

AUGUST, 1937

RADIO RETAILING

McGraw-Hill Publishing Company, Inc.

25 CENTS-PER COPY

Six visible reasons why it pays to feature
RCA Victor's Sensational 1938 Line!



RCA Victor Electric Tuning! The first truly automatic tuning. Just push a button—there's your station! Long-lasting and fool-proof. Any 8 stations. It's another RCA Victor first—a real sales clincher that makes buyers out of prospects!



RCA Victor Overseas Dial! One of four new RCA Victor easy-to-tune dials. Makes foreign tuning easier than domestic tuning by spreading short wave stations 50 times wider—ordinary $\frac{1}{4}$ " scales extended to $9\frac{1}{2}$ " each! Foreign city names on dial!



RCA Victor Armchair Control! Makes it possible to tune from any armchair, or from another room! Like Electric Tuning, RCA Victor Armchair Control is automatic, practical, virtually fool-proof. Applicable to any Electric Tuning Model. A sure-fire selling feature.

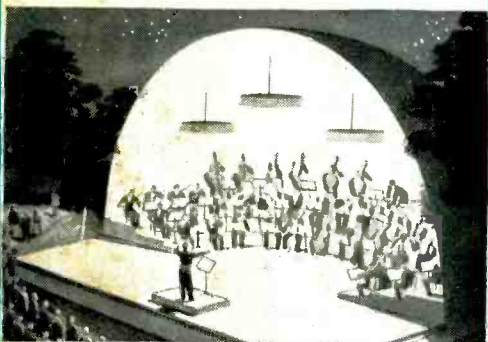

RCA Victor Sonic-Arc Magic Voice! It's new. It's improved. It's a demonstrable feature. New construction employs band-shell principle, traps "boom," provides finer tone than ever before. This is an even better sales feature than first Magic Voice!



RCA Victor Beauty-Tone Cabinets! Made by skilled craftsmen in the world's oldest and finest radio cabinet factory, the 1938 RCA Victor instruments feature cabinets whose acoustic perfection means beauty of tone as well as appearance.

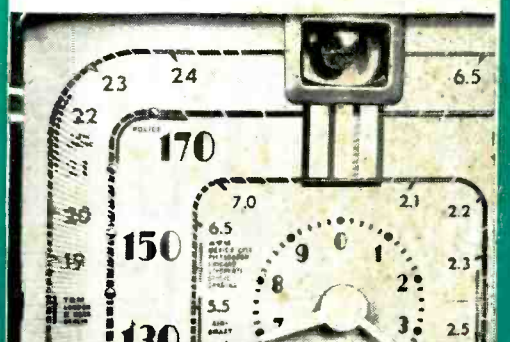

RCA Victor Magic Eye! The famous Magic Eye is again an outstanding RCA Victor feature, this year as a part of the dial. Magic Eye is the most accurate known method of manual tuning. It now applies on short wave as well as standard broadcasts.

BESIDES the six outstanding visible features shown on this page the great new 1938 RCA Victor line gives you 49 others—all factual evidence of true quality.

You will find this line easy to sell because it offers outstanding value—and because RCA Victor backs it up with sales-compelling advertising and promotional campaigns. Get full details from your RCA distributor.

RCA presents the "Magic Key" every Sunday 2 to 3 P. M., E. D. T. on NBC Blue Network

RCA Victor

RCA MANUFACTURING CO., INC., CAMDEN, NEW JERSEY
A SERVICE OF THE RADIO CORPORATION OF AMERICA

DEPENDABLE PERFORMANCE



**No SKINNY
MICROFARADS**

in **MALLYORY**
REPLACEMENT
CONDENSERS

When you buy Mallyory Replacement Condensers you get full capacity. There are no "skinny mikes" to account for... no *lean* performances to alibi.

The generous capacity of Mallyory Condensers is important. So is the lower power factor. Together they mean improved filtering and better performance. And—better performance means better satisfied customers.

What is done to assure the *permanence* of Mallyory Condenser characteristics?
Plenty!

The famous Mallyory Metal Seal *hermetically closes* each Mallyory Condenser against the effects of moisture and dryness.

That's why you can depend on Mallyory Replace-

ment Condensers for dependable performance any time, anywhere—at the seashore or in the Sahara Desert.

Mallyory Replacement Condensers have established a position of national leadership in the service field—yet Mallyory Replacement Condensers cost no more. The longer you use them the more readily you'll agree that they actually *cost less in the long run!*



**Are You Missing the Biggest
Help a Service Man Ever Had?**

Have you delayed asking the Mallyory-Yaxley distributor about *your* copy of the MALLYORY-YAXLEY RADIO SERVICE ENCYCLOPEDIA? See him now before the edition of this great book is exhausted.

Use
P. R. MALLYORY & CO. Inc.
MALLYORY
REPLACEMENT
CONDENSERS... VIBRATORS

P. R. MALLYORY & CO., Inc.
INDIANAPOLIS INDIANA
Cable Address—PELMALLO

Use
YAXLEY
REPLACEMENT
VOLUME CONTROLS

RADIO RETAILING

AUGUST, 1937

O. FRED. ROST Editor
 W. MacDONALD Managing Editor
 C. A. NUEBLING Technical Editor
 T. H. PURINTON Assistant Editor
 HARRY PHILLIPS Art Director

Tom Blackburn Chicago
 George Tenney San Francisco
 H. S. Knowlton Boston

HOWARD EHRLICH
 Executive Vice-President

H. W. MATEER
 Manager

RADIO MONTH	By O. Fred. Rost	7
DISPLAY — MANAGEMENT — ADVERTISING — SELLING		11
FIGURES		15
HUSBANDS AND WIVES		16
COST ACCOUNTING FOR SERVICE	By Russell B. Rich	18
FARM MARKET FACTS		21
LOW-DOWN ON HIGH-LINES	By D. C. Frederick	22
POWER TO SUIT THE PURSE	By Tom Blackburn	24
FACTS ABOUT BATTERIES		26
SOUND ON A SHOESTRING	By Bob Wright	28
SOUND EFFECTS		29
AUGUST NEWS		31
PREVIEW OF NEW PRODUCTS		47
CIRCUITS		61
SOUND		63
SIGNAL GENERATOR AND CONDENSER BANK	By Jim Kirk	65
SHOP SHORTCUTS		67
TRICKS OF THE TRADE		71
LETTERS		80

McGRAW-HILL PUBLISHING COMPANY, INC.

Publication Office
 99-129 North Broadway, Albany, N. Y.
 Editorial and Executive Offices
 330 West 42nd Street, New York, N. Y.

Cable Address: MCGRAWHILL, New York
 Member A.B.P. Member A.B.C.

James H. McGraw, Jr. President
 Howard Ehrlich Executive Vice-President
 James H. McGraw Honorary Chairman
 B. R. Putnam Treasurer
 D. C. McGraw Secretary

RADIO RETAILING, August, 1937, Vol. 22, No. 8.
 Published monthly, price 25c copy. Subscription rates—United States and possessions, Canada, Mexico and Central American countries \$1. All other countries \$2 a year or eight shillings. Printed in U. S. A. Entered as Second Class Matter, September 8, 1936, at Post Office, Albany, N. Y., under the Act of March 3, 1879. Cable address "McGrawhill, New York." Member of A.B.P. Member of A.B.C. Copyright 1937 by McGraw-Hill Publishing Co., Inc., 330 West 42d Street, New York, N. Y.

Branch Offices: 520 North Michigan Ave., Chicago; 883 Mission St., San Francisco; Aldwych House, Aldwych, London, W.C. 2; Washington; Philadelphia; Cleveland; Detroit; St. Louis; Boston; Atlanta, Ga.

SALES STATIC . . . IT JUST SMOKES A LITTLE. WHY CAN'T YOU FIX IT HERE?



Sell

**— TONE...BEAUTY
ACTION...VALUE —**



— and you have a
SATISFIED CUSTOMER



No. 231-F Coffee Table. Price. **\$155**



No. 231-R Arm Chair. Price . . . **\$145**

This is fundamental. And in *Tone*, on account of the Acoustical Labyrinth and Carpinchoe Leather Speaker, Stromberg-Carlson stands apart . . . in *Beauty*, the cabinets by Worthington speak for themselves . . . in *Action*, Flash Tuning and Telektor Automatic Remote Control, among other features, provide every operating convenience that radios possess . . . in *Value*, every model from \$57.50 to \$1050, offers more than can be obtained in any comparative set.

Prices quoted are for all sections except Southeastern States and West of Mississippi.

**STROMBERG-CARLSON TELEPHONE MFG. CO.
ROCHESTER, N. Y.**



No. 240-S Drop-Door Console with Labyrinth. Price . . . **\$250**



No. 240-W Mahogany Desk with Labyrinth. Price **\$250**

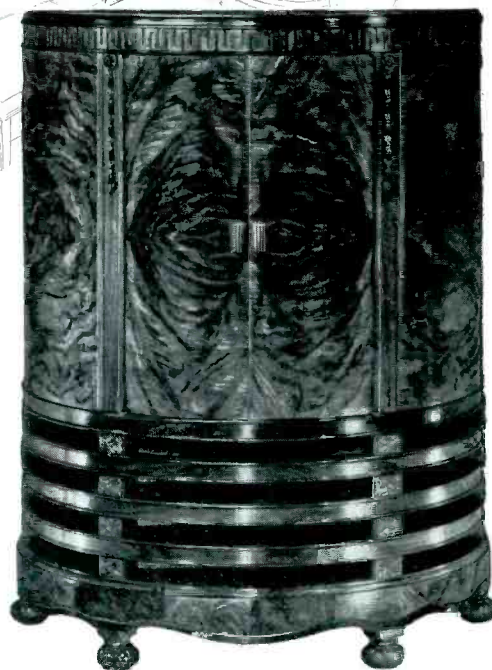

No. 240-R Half-Round Console. Price . . . **\$215**

There is nothing finer than a
Stromberg-Carlson

3 NOTABLE ADDITIONS TO A DISTINGUISHED LINE AND 3 REASONS WHY YOU WILL SELL THEM



MODEL 425A



MODEL 325



MODEL 280

- 1—They Have a Good *Name*.
- 2—They Have the *Features*.
- 3—They Have the Right *Price*.

Model 425A—Designed to hold its own in fast company. Has everything — *will do everything* that John Q. Public expects of a radio *de luxe*. Yet we price it to you at a figure that will enable you to do business with *Trader-Inners* without losing Your Shirt. *Look at these Features:* 8 Station Push Button Tuning (motor driven) — Brings 'em in on-the-head and does it instantly! Bass Boost. Push-pull Beam Power Output (14 watts). Three bands, 18,000 to 540 kc. Edgelight dial. Flashy dial and gold plated escutcheon. Copper plated chassis. 15-inch speaker. Massive cabinet. 14 tubes.

Model 325—As practical as it is beautiful. Control panel has just enough tilt to make tuning easy from a standing position without making it look more like a cash register than a radio — *as some of the new bend-over eliminators do*. Push-pull Beam Power Output. Three bands, 18,000 to 540 kc. Distinctive three-color edge lighted dial with gold plated escutcheon. Copper plated chassis. 12-inch speaker. 10 tubes.

Model 280 — We put a lot of time in on this one to make sure you HOWARD Dealers would be all set for the big turn to Arm Chair Models which is predicted for the Fall. We believe we have here just about what it takes to get you the business. A swell cabinet, beautiful tone, and a price that will surprise *even you!* Beam Power Output. Three bands, 18,000 to 540 kilocycles, copper plated chassis. Impressive dial with big easy-to-read markings. Edge lighted. Gold plated escutcheon. Six tubes that perform like eight. 12-inch concert dynamic speaker.

The HOWARD Line is the line for YOU. At least you owe it to yourself to investigate our proposition. Write or wire TODAY for our Dealer's or Distributor's proposition. It will only take a moment, so why not do it NOW!

HOWARD RADIO COMPANY

1735 BELMONT AVENUE • CHICAGO

CABLE ADDRESS "HORAD"

Only RCA Radiotron offers this valuable complete service!

Sales Aids . . . Store Equipment . . . Technical and Business Helps—RCA offers them all in this non-profit service to Dealers and Service Men

SALES AIDS



The Tube display shown is life-size—a dramatic, appealing interior or window display that attracts attention. Part of year-round window display service.

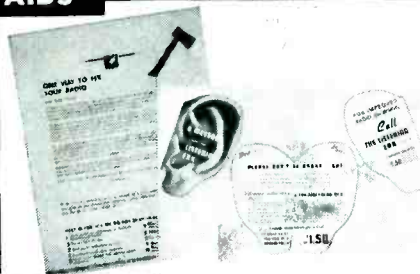

Many tested direct mail pieces like the famous Hatchet Letter and the Listening Ear Card shown here are forceful sales producers. RCA provides them with your imprint—inexpensively.

STORE EQUIPMENT



This Neon Sign is unique! Famous RCA Monogram glows when bulb is put in electric outlet. Special device permits "RCA" to face in any direction. An ideal night light. Only 60¢



The Metal Flange Sign (left) means quick identification. Durable. Four-color enamel job, with your name on bottom panel. Also available a novel Three Dimension Mirror Sign.

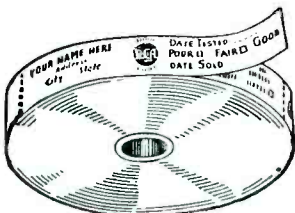

RCA offers imprinted Tube Test Stickers—that do not char from use on metal tubes—and Package Tape Machine that can also be used to hold stickers.



A beautiful two-color 20-inch diameter Illuminated Clock with Hammond motor is amazingly inexpensive. An outstanding value from an advertising and practical standpoint.

Other store equipment that increases your prestige, builds customer confidence—and which only RCA offers at very low cost—includes leaflets, book matches, service garments, lantern slides, etc.

TECHNICAL HELPS



The RCA Service Engineers Pencil. A necessity for service engineers. Has non-metallic screw driver under metal tube cap, and patented resistor drums are made of celluloid composition, so they cannot wear off.

Other technical helps that answer puzzling questions include Socket Layout Guide, RCA-Radio Tube Manual, RCA Pin Index and many others—all yours at extremely modest cost.

BUSINESS HELPS



"Radio Service Business Methods" by John F. Rider and J. Van Newenhuizen, tells you how best to conduct your business profitably. "101 Service Sales Ideas" is a booklet of fact—every idea a successful one.

RCA also offers you the only complete Service Accounting System available—with printed forms to cover every phase of your business.

FREE

A wide variety of counter displays is available without cost—while they last. Full details from your distributor. Get yours now. Full details about all the above items—plus many others RCA has for you—in free booklet "RCA Radiotron Sales Aids for Radio Dealers and Service Engineers" Ask your distributor for your copy today—or use the coupon.



Radiotrons

RCA MANUFACTURING COMPANY, CAMDEN, NEW JERSEY
A Service of the Radio Corporation of America

RCA Radiotron Division, RCA Manufacturing Company, Camden, New Jersey

Please send me without cost or obligation the booklet "RCA Radiotron Sales Aids for Radio Dealers and Service Engineers".

Name _____

Street _____

City _____ State _____



**A FULL PROFIT
ON GAS-ENGINE
BATTERY
CHARGERS**

**- AND AN
EXCLUSIVE PATENTED
FEATURE THAT
EVERYBODY WANTS**

Before you tie up with ANY gas-engine battery charger deal, see what Continental Motors offers!

FULL PROFIT PROTECTION. Continental believes "every barrel should stand on its own bottom." Continental's TINY TIM battery charger helps you sell a good radio—at the same time it gives you your full profit!

NO COMPETITION! Continental—and ONLY Continental—offers (1) Patented CONTROLLED VOLTAGE generator that positively prevents injury to battery or radio tubes, and (2) Patented AUTOMATIC SHUT-OFF, which makes it unneces-

sary to watch or test the battery while it is being charged! When the battery is fully charged, TINY TIM automatically stops! Here are convenience and economy that every user appreciates.

THE CONTINENTAL NAME! A long accepted symbol of engineering excellence.

NATIONAL ADVERTISING! Farm paper advertising backed up with generous sales helps.

Investigate today! Wire, write or mail the coupon!

\$45.00 LIST

F.O.B. Detroit

TINY TIM, JR.

- 6 Volts, 150 Watts
- Controlled Voltage Generator
- Push-Button Self-Starter
- Automatic Cut-out
- Wood Base
- 2 Qt. Gasoline Tank
- Ammeter
- Attractive Red Finish
- Overall Weight, 50 lbs.

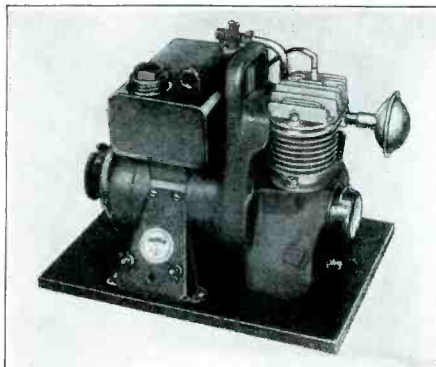

\$57.00 LIST

F.O.B. Detroit

TINY TIM, Model 60

- 6 Volts, 240 Watts
- Controlled Voltage Generator
- Automatic Shut-off
- Push-Button Self-Starter
- Automatic Cut-out
- 2 Qt. Gasoline Tank in Cast-Iron Base
- Ammeter
- Attractive Maroon Finish
- Overall Weight, 65 lbs.



\$60.00 LIST

F.O.B. Detroit

TINY TIM, Model 120

- 12 Volts, 300 Watts
- Controlled Voltage Generator
- Automatic Shut-off
- Push-Button Self-Starter
- Automatic Cut-out
- 2 Qt. Gasoline Tank in Cast-Iron Base
- Ammeter
- Attractive Orange Finish
- Overall Weight, 69 lbs.



\$70.00 LIST

F.O.B. Detroit

TINY TIM, Model 320

- 32 Volts, 300 Watts
- Controlled Voltage Generator
- Automatic Shut-off
- Push-Button Self-Starter
- Automatic Cut-out
- 2 Qt. Gasoline Tank in Cast-Iron Base
- Ammeter
- Attractive Green Finish
- Overall Weight, 69 lbs.

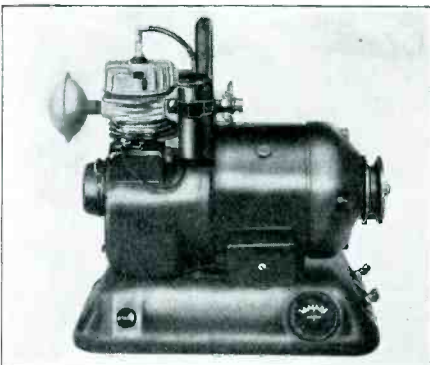

32 Volt 110 AH Battery \$45 List

Tiny Tim *Controlled Voltage* BATTERY CHARGERS

POWERED BY THE FAMOUS

Continental

MAIL THIS COUPON NOW

Red Seal Engine

CONTINENTAL MOTORS
DETROIT, MICHIGAN

I want my full profit. Rush full details on Continental Tiny Tim Battery Chargers.

Name

Address

City State



WILCOX-GAY
AND WILCOX-GAY ONLY--
CAN GIVE YOU THESE
TWO MODELS

YOUR FAVORITE STATIONS WITH THE FLICK
 OF YOUR FINGER

Think of it!

... MORE BUSINESS

This strikingly beautiful arm chair receiver with genuine automatic straight line tuning . . . **\$44.95**

Five tube, AC, three gang superheterodyne. Has ten station automatic tuning, automatic muting, quick manual tuning, AVC, edge light glass straight line dial, two band giving broadcast, police and foreign reception. Size 20½ x 18 x 10½". The world's most convenient radio.

Model A-33 Table Model. Same features as arm chair set described above. Size 16¾ x 9½ x 8¼". The season's most sensational value. **\$34.95**



The complete Wilcox-Gay line offers you eight great receivers in console, chair-side and table types, all representing the same outstanding values as these two numbers.

Make Wilcox-Gay your radio line this year and profit from these advanced features, generous discounts and great values. Write for name of your nearest Wilcox-Gay distributor and complete information.

To distributors—Wilcox-Gay offers a trouble free line of high quality radios, cleanly merchandised. If interested, wire or write us at once. Full line export models available for foreign distributors.

WILCOX-GAY CORPORATION

Charlotte

Michigan

U. S. A.

WILCOX-GAY—QUALITY RADIO SINCE 1919 — WILCOX-GAY

The RADIO MONTH

Prices Climbing Indications are that most radio set prices will be raised before the big fall selling season commences. Raw materials are up and labor costs are steadily going higher.

Manufacturers are already jammed with orders for sets. Some are paying premium prices to get delivery on essential parts. Most set makers are in the same boat, having quoted extremely close lists on hot models. Thus increasing material and labor costs squeezes them all alike, with the result that no one manufacturer will be likely to make capital of increases in competitive line lists by keeping his own down.

Blue Sky With orders on hand that are double and even 3-times the total of last year, same period, several set makers whom we visited in the last 2 weeks are actually alarmed and even frightened by this unprecedented situation. They themselves can't explain it on the basis of past performance. Their distributors can't shed any light on the situation, other than to say that to judge by the way sets are moving now, they will need all they are ordering after the fall buying season gets under way. Their dealers simply are busy making sales and do not seem greatly concerned if the cumulative effect of their replacement orders is giving some manufacturers a headache. Undeniable fact is that the radio set business is running in high gear.

Thrill Buying Of that scheduled avalanche of advertising of new models with automatic, electric or some other type of on-the-nose tuning, only a trickle has had a chance to reach the public but already the reaction has been so instantaneous, so definite, so decisively favorable that it does not need a crystal-gazer to predict that those new tuning gadgets will turn the trend of normal replacement buying into a wave of thrill-buying. Everybody will want one of those new radios because every-

body suddenly will discover something about the old set that is distinctly inconvenient or out of date. Grandma needn't look for her glasses. Grandpa won't have to stoop down. Ma can switch from sister Sue's jazz program to Kitty Killwork's Kitchen Hints before Sue can untangle herself and beau, while Pa, who merely pays for it, sees a chance of sneaking up once in awhile and pushing the button for a prize fight or the baseball scores, before the family can stop him.

Bottle-Neck Ten to one that if any distributor or dealer finds certain models back-ordered persistently, the manufacturer will blame the delay on the cabinet maker. A few farsighted production wizards, who had their hand on the public's pulse and their ear to the cabinet makers' inner office partition knew that lots of cabinets were going to be ordered and that they were going to be hard to get. They ordered early, have cabinets stored all over the lot and in warehouses, are going to be able to make prompt shipments. Others who tarried with design or first wanted to see what their competitors were going to offer, find themselves in a jam—some haven't even shipped complete sample lines to their distributors. So the furniture makers now are the bottle-neck for radio set production excepting—where plastics cabinets are used. We saw one molding plant turning out nearly 1,000 molded radio cabinets per day—without crowding.

Seven Up The Federal Trade Commission reports that seven automobile manufacturers have signed stipulations "to cease using false and misleading representations in advertising." Hereafter in their advertisements they must show their cars as they propose to deliver them, at the advertised price and not all decked out with "extras" (including radio) which the unsuspecting

consumer thinks are included in the advertised price but which actually are charged as *extras* when he finally comes to buy the car. This means that those manufacturers will hesitate to ship their dealers cars equipped with "extras" (including radio) unless actually ordered because then the dealer would not be able to deliver cars actually as advertised. The net result of this action should be—more auto radio business for the local radio dealers and distributors, especially if they team up with local car agents.

Farm Income The government has just released a statement that farm income in June 1937 was 604 million dollars, which is 17 million above 1936, and incidentally the highest since 1930. In addition, the U. S. Treasury put 27 million dollars more into farmers pockets during June in connection with the agricultural conservation program. Meanwhile the nation's farmers have been going to market in July with bigger crops than in many years and they are collecting better prices than in years.

Combinations Click When the tale of 1937 set sales is told it will carry a rude jolt for those who have snubbed the idea that combination radio and phonograph units are "hot" and that sales of phonograph records just trail along as small profit-making "plus" values. There is no longer any doubt—combinations are clicking. They run into money and the people who buy them are the best type of customer. One set maker who included some combinations in his new line reluctantly, actually has *doubled his order for cabinets twice* since June.



EDITOR



THE KEY TO THE GREAT FARM RADIO MARKET

THE GENUINE

WINCHARGER

REG. U. S. PAT. OFF.

6 VOLT DE LUXE

Your Most Dependable Least Expensive Source of
ELECTRIC CURRENT FOR FARM RADIOS

YOUR farm customers want dependable "big-city" radio reception. You can give it to them with any good 6-volt farm radio —*powered by Wincharger!*

They want freedom from "B" batteries and expensive recharging. You can give it to them—*with Wincharger!*

They want low-cost operation. You can make their power operating cost less than 50c a year—*with Wincharger!*

They want years of dependable, proved, trouble-free performance.

And your logical answer is —
Wincharger!

That's why Wincharger is the **KEY TO THE FARM MARKET** —the *greatest remaining radio market*. Records show that 79% of all city homes now have good radio sets, but **66% of all farm homes need new radios!** There are 4,602,000 farm homes that must depend on battery operated radios! Wincharger provides the cheapest, most dependable, most satisfactory answer to the farm radio *power problem*.

**\$2.50 PROFIT FOR YOU
 in Every Wincharger You Sell!**

WINCHARGER not only opens the great farm radio market for you—but there's a \$2.50 cash profit in every Wincharger you sell. It makes no difference whether the customer buys in your store, or orders direct from the factory on a coupon bearing your name. Be sure your name appears on the Wincharger Co-operative Purchase Coupon in every radio you sell!

Only Wincharger can offer your customers a record of proved satisfaction for more than 500,000 delighted listeners all over the world! Only Wincharger has been tested and proved by the engineers of every

leading radio manufacturer! Only Wincharger offers you, the dealer, such assurance of customer-satisfaction and trouble-free performance, year after year!

Tie your selling program to Wincharger! It's known for dependability wherever farmers read farm papers. It's being advertised this season to millions of farmers all over the country—to thousands right in your own territory. Made by the world's largest makers of wind-driven generating equipment, and guaranteed, "Satisfaction or Money Back."

**WINCHARGER CORPORATION
 SIOUX CITY, IOWA**

World's Largest Makers of Wind-Driven Generating Equipment



Wincharger Corporation, Dept. RR 8-37
 Sioux City, Iowa
 Please send your new manual,
 "MORE FARM RADIO SALES"

Name.....
 Address.....
 City..... State.....
 Make of radio handled.....



They're ALL in the Market!

Be sure your tube policy is sound—and sell them tubes that enhance your reputation for dependability!

• • •

This year the industry is selling a lot of radio merchandise. Are you getting your share?

If you've been selling good tubes like Sylvania's—your chances are bright. If you have been tempting trouble with "cheap" tubes... switch

to Sylvania's now, and build confidence among the very people who are "in the market" for new sets.

Sylvania quality is guarded through scores of exacting tests during every step of manufacture. No tube ever leaves the Sylvania factory unless it is sure to function perfectly. Sell Sylvania's—they'll tone up your business. For complete sales and technical information, write to Hygrade Sylvania Corporation, Emporium, Pa.

SYLVANIA **THE SET-TESTED
RADIO TUBE**

Dependable Power Makes Sales Easier

The world-wide reputation of Briggs & Stratton 4-cycle gasoline motors has an important influence on your sales . . . People everywhere know of these famous motors and of the unusually long and trouble free service they render. When they see one of these rugged, reliable motors, they feel that the entire unit must be dependable . . . Briggs & Stratton 4-cycle gasoline motors drive over 90% of all makes of farm washing machines. They also power most small pumps, small tractors, lawn mowers and an endless variety of other motor driven farm tools. Insist on Briggs & Stratton motors on all the equipment you handle and you will find larger sales—greater profits. Power by Briggs & Stratton, makes any equipment easier to sell.

BRIGGS & STRATTON CORP.
MILWAUKEE, WISCONSIN, U. S. A.

POWER by

4
CYCLE

BRIGGS & STRATTON
MILWAUKEE, WIS. U. S. A.

GASOLINE
MOTORS

DISPLAY....MANAGEMENT....ADVERTISING....SELLING....

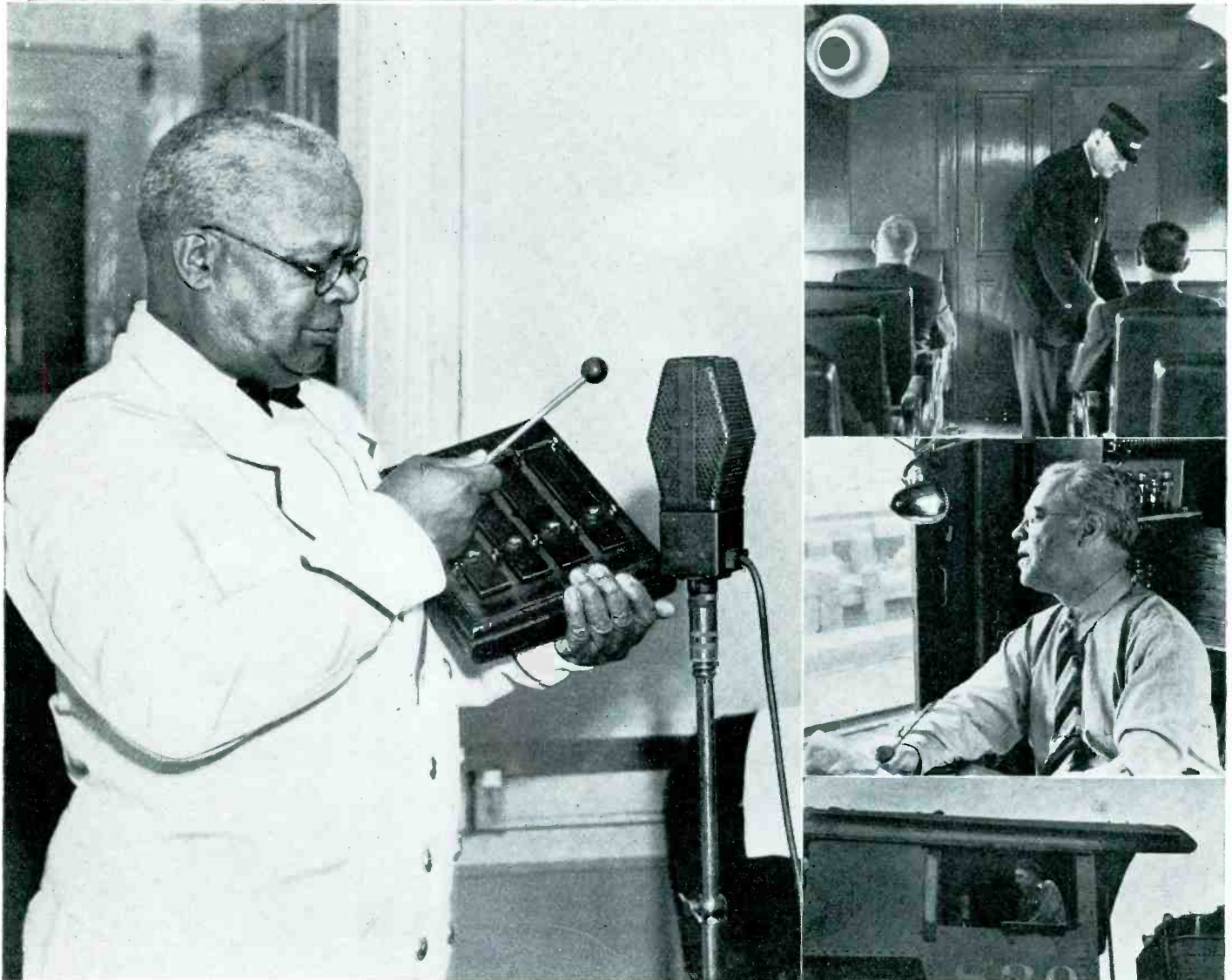

DINNER WON'T WAIT

NEWARK — "Rubberneck" trains, summer-sequel to the widely successful "Snow" trains, are equipped with sound by the enterprising Central Railroad of New Jersey, now offering novel sightseeing cruises-on-land to tourists.

Into the discard goes the quaint but inefficient wandering-waiter-with-the-gong. For, standing before a modern microphone in the dining car itself he now calls all rubberneckers to food without stirring a step.

In each day-coach (upper-right) speakers repeat the message.

From the amplifier-equipped baggage-car, its door rolled open (center-right) to permit an advance-glance of approaching points of scenic and historic interest, sits an announcer. He's provided with a typewritten guide, periodically calls interesting views to the attention of passengers.

Recorded music is frequently played over the system. And novelty is supplied by installing a microphone (lower-right) in the locomotive-cab, amplifying the engine's whistle, the roar of the driving-wheels, conversation

of the crew. Conductors, further, are introduced as they pass through the train.

To this railroad, for sponsoring another new and practical use for sound . . . the honor of our first-page position for the month!

Potted Plants, Paint

SULLIVAN, MO.—Half the population of this town attended a household appliance show featuring Grunow refrigeration and radio, ABC washers and Universal ranges when its sponsor, the Sullivan Motor Company, promised a potted flower to each lady and a can of enamel to each man attending the show.

DISPLAY MANAGEMENT

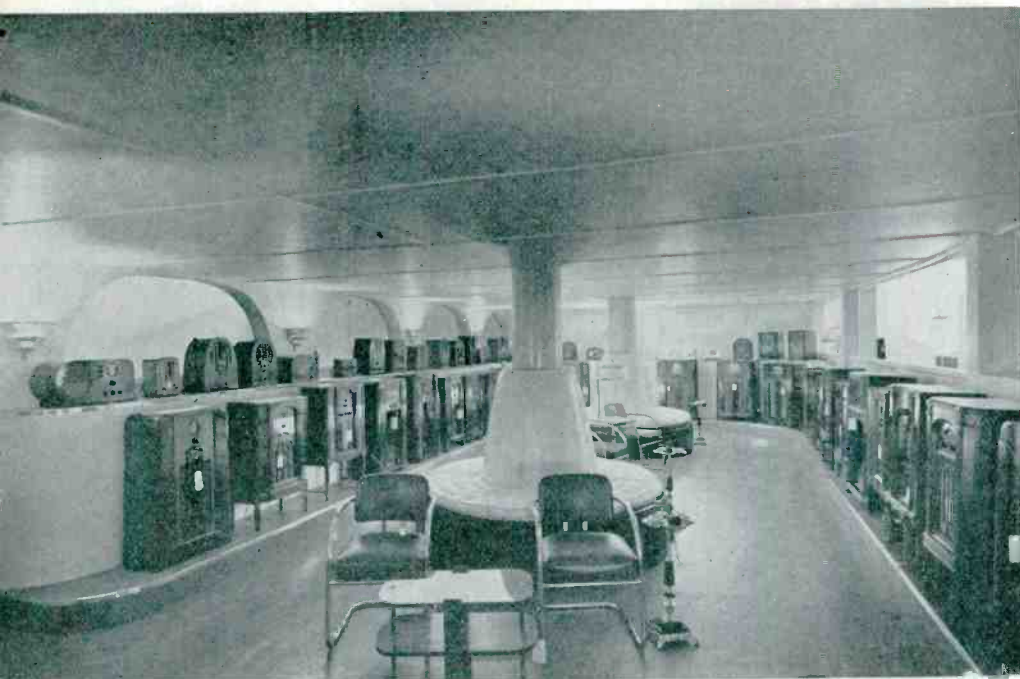

RENOVATION IDEA—Beneath a balcony with an ugly, square-nosed approach, rough, spindly supporting posts, Home Furniture Company of Dallas' radio department was severely handicapped. Now it looks like this. Posts at the balcony edge were built out to resemble arches, with composition board. Central posts were enlarged with the same material, circular seats provided. Blue was used overhead, yellow with blue trim and silver bands for the walls. Seats are in white leather. W. P. Kelly, store manager, says the change was not expensive, has boosted business

PROMOTION PAST-MASTER —

To introduce new radio models with a splash, salesman Frank Redmond of Springfield, Illinois' A. Dirksen & Son enlisted the cooperation of 6 newspapers, staged a beauty competition for the city's femininity. To qualify, girls had to score 100,000 votes. Five-thousand ballots were given to each person buying a \$100 set and proportionately more or less for purchases at other lists. Sixty entered, 14 qualified and were judged at a celebration ball following a high-noon, brass-band parade. Free tickets to the ball were given to all who left their names and addresses at the store.

Total cost: \$250



\$20,000 ROAD SHOW — To 30 State and County Fairs, Alfalfa Days and Corn-Husking Contest go four displays like this between now and October on half-ton trucks manned by Wincharger men. They expect to cover 22,000 miles, demonstrate to at least 500,000 farmers.

CONTROL THOROUGH DISPLAY—Pinch-hitting for vacationing appliance manager H. W. Cole of Hart Furniture, Dallas, Marvin Lunsford shows how new stair-step shelving automatically emphasizes certain table models without hiding others. Records show that top-shelf items, just below eye-level, sell faster than those one step lower. Recessing of consoles gives them additional dignity, protects cabinets, too



Business by Bonus

MILWAUKEE—A different kind of a bonus system, whereby home office employees share the outside crew's earnings, has just been instituted by the Taylor Electric Company of this city and Madison.

Under this system a salesman earns a bonus above his salary, based on the company's profits from sales in his territory. Half of it is, however, placed in a general fund to be divided among inside employees.

Often, a customer contacted in the field will come to the store for a demonstration and it is rarely profitable for the salesman to cancel outside work in order to be on hand. So salesmen simply telephone some member of the office force, rely upon them to do a good job which means bonus to both.

Five Best Months

ROCHESTER—The five best months for radio sales are just ahead, according to Lee McCanne, radio sales manager for Stromberg-Carlson. Explains Mr. McCanne:

"The radio industry is smart to start early this year. First, because people

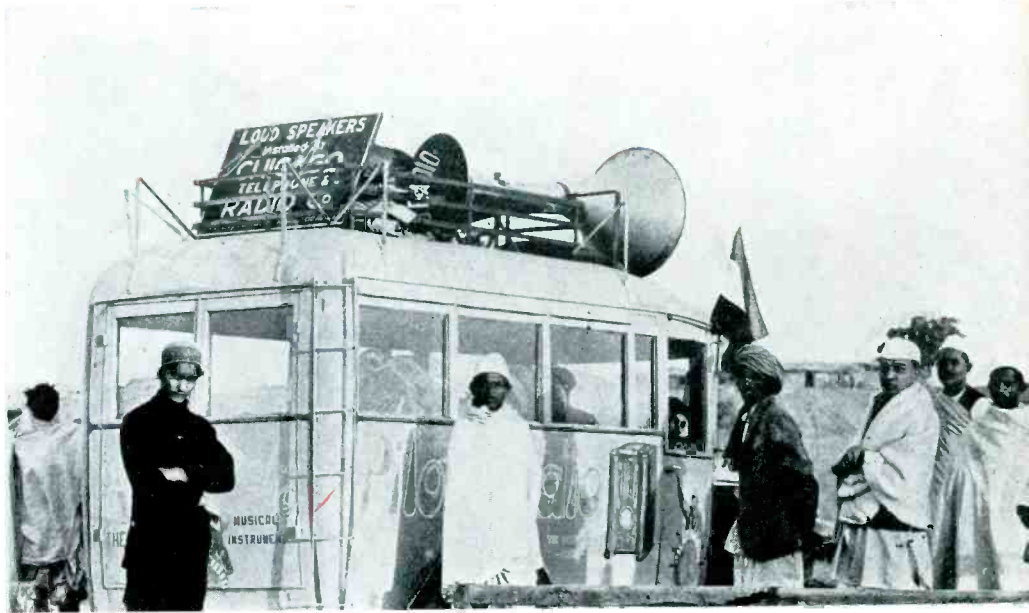

SOUND SELLS IN INDIA—Pilot radios move faster for the Eastern Electric & Engineering Company of far-off Bombay when this p.a. truck ballyhoos to the natives

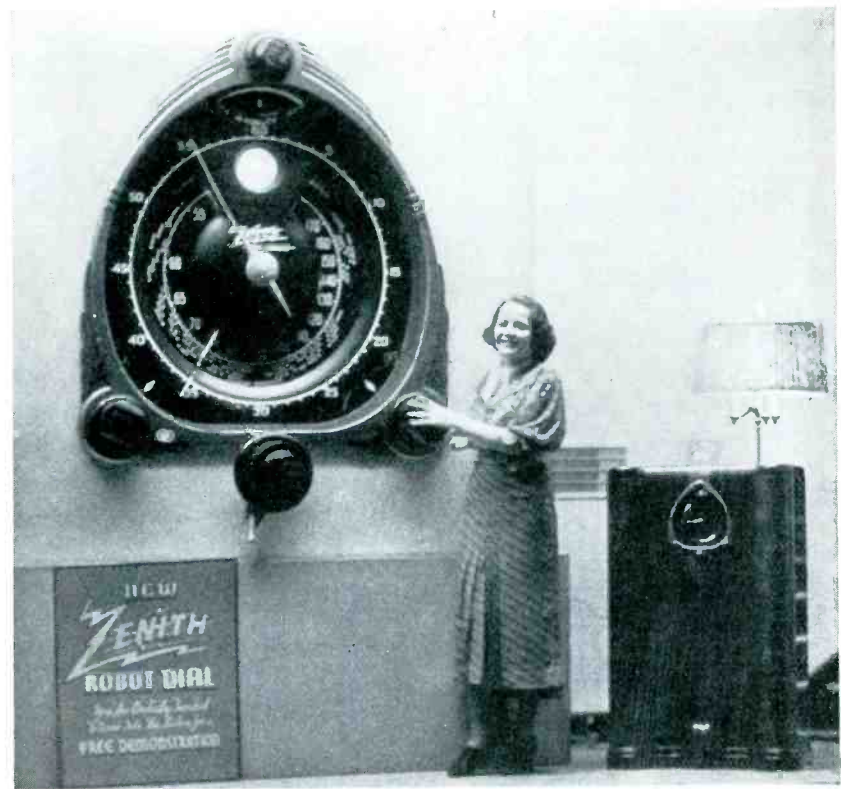

BIG ROBOT—In the window of Chicago's Zenith Radio Distributing Corp., this ten-foot high dial tuned by a pretty girl stopped traffic

want new radios. Second, because over 50 per cent of the sets now in use can't receive shortwaves. Third, because in the next few months shortwave reception is at its best and is most important to the listener.

"In the next few months there are more hours of daylight than of dark-

ness. Shortwave reception is best in the daytime. There are several months of vacation time, when people travel, go to summer camps or live in trailers. Shortwave radio spans long distances, allowing them to keep in touch with favorite programs. There are, too, several months of stormy weather, when



HOME: ONE CHAIR — George Turney, of Houston's Crumacker Distributing Corporation is getting wads of useful publicity in the public prints with an all-purpose chair of his own design. It contains a radio, electric clock, telephone, convenience outlets, game-board, magazine rack, bar, reading light, humidior, thermometer and only Mr. Turney knows how many other things. He's thinking of building a footstool with a built-in electric fan and heater!

lightning and fading spoil reception on the broadcast band.

"There are several months of daylight saving time, when people rise earlier than usual and can listen for early morning programs from the Orient. Evening shortwave reception is strongest from the east, while early morning reception favors stations from the west. In addition, there is unusual activity on the aircraft channels, as most trans-ocean flights are made at this time.

"And at the end of this summer period the holiday buying surge begins."

Babying Walnut

CHICAGO—From the American Walnut Manufacturers Association come the following suggestions for the display of walnut cabinets, dominating the radio field today:

"A walnut radio cabinet will appear least striking against a background of the same hue and tone; more striking against a background which is either lighter, darker, or of a different hue than itself; and most striking against black or white.

"Against a background lighter than itself, walnut will appear darker, with this effect increased in the degree that the background tone approaches white; while against a background darker than itself it will appear lighter, with this effect intensified in the degree that the background tone approaches black.

"Pure white or dead white is a trying background for all cabinet woods. When used, white should be faintly tinged with a hue, and in the case of walnut this hue should be warm, e.g., a creamy, rosy, or greenish white, but not a bluish or purplish white.

"Walnut is equally effective against plain, self-toned, or multi-colored backgrounds, provided that the latter are not so striking as to throw into eclipse either the handsome figure of the wood or the details of the design. In general, it is better to use a plain or self-toned

wall background, and to introduce the ornament and color necessary to make the display interesting in floor coverings or hangings, coverings, pictures and other accessories.

"Walnut has a warm, relatively neutral coloring, and is harmonious with all the hues. It is unpleasing (as are practically all furniture woods) with the cold grays, whether light or dark.

"For effective accents with walnut, use rich, full-bodied reds, yellows, greens or blues; any of the metallic colors, from silver to copper; creamy white or black. For displays of modern walnut which include chromium, use accents of black, rich reds or blues.

"In general, use a floor covering at least as low in tone as the walnut cabinets displayed on it, and preferably somewhat darker. This is particularly important in the case of fairly large pieces of furniture.

"Either plain or figured floor coverings can be used with walnut cabinets of any type, subject to these qualifications: Do not use bold designs and striking colorings under cabinets which have slender proportions, delicate detail, or finely figured face veneers that you wish to emphasize. The eye is compelled to pay greater attention to the more powerful stimulus. Do not use a floor-covering of straight-line, angular design under cabinets in which graceful curves are emphasized. The rug will spoil the appearance of the cabinets. An all-over carpet or large rug tends to invest a room setting with the effects of spaciousness, unity and repose. Small rugs reduce the appearance of spaciousness, and create effects of variety and animation. When either much lighter or much darker than the floor against which they are seen, small rugs are spotty and over-conspicuous, and thus tend to distract attention from the furniture displayed with them.

"Study the daytime lighting on your walnut cabinet windows from the outside of the store, because sales will be

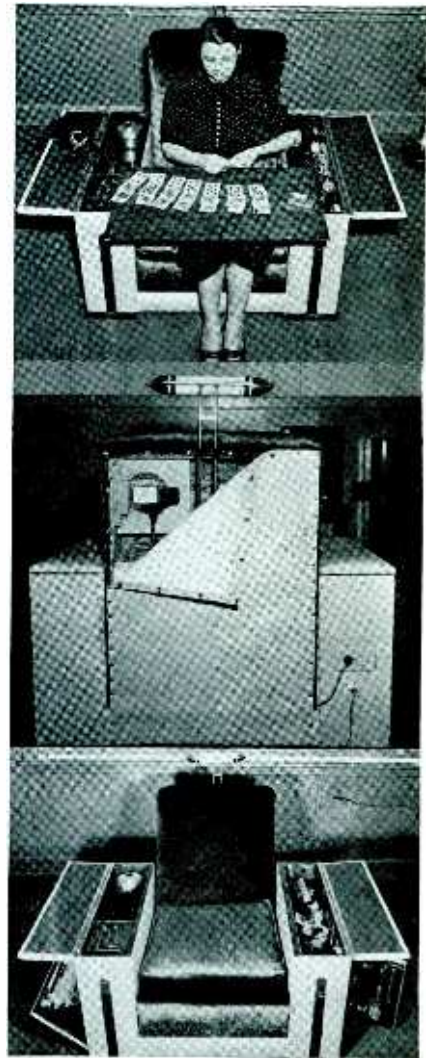

lost when the lighting is such as to obscure, or to make the coloring seem gray and weak. Sometimes it may be necessary to change the angle of important cabinets slightly, or to substitute a large rug for several smaller ones, in order to kill reflections which in turn kill the beauty of your wares.

"If you use colored bulbs or screened spotlights for high lighting, be sure that their effect is to bring out and emphasize the beauty of the wood. Walnut will look gray or black under blue, violet, or greenish-blue light, but will be enriched by yellow, orange or red.

FIGURES

RADIO RETAILING'S MONTHLY BUSINESS BAROMETER

FARMERS PAY

Although they have extension and deferred payment privileges, the farmers of the country are paying off their mortgage indebtedness to the government promptly, according to Gov. W. I. Myers of the Farm Credit Administration. The percentage of loans in good standing, 55 per cent in 1932, 77 per cent at the end of 1935, 85 per cent on December 31, 1936, rose to over 87 per cent on June 1, 1937, end of the fiscal year.

MILWAUKEE'S RADIOS

From the *Milwaukee Journal's* latest consumer analysis we learn that 98.6 per cent of the homes in the Greater Milwaukee area were equipped with radio on January 1 as against 97.4 per cent the previous year. 84.7 per cent of the radio owners had just one receiver, 13.8 per cent had two and 1.5 had three or more.

In addition, 21.3 per cent of all Greater Milwaukee families owned auto-radios as against 14.4 per cent in 1936.

PIANOS PERK

Piano sales in 1937 are likely to exceed 130,000, according to W. A. Mennie, secretary of the National Piano Manufacturers Association, who reports that 49,595 units were shipped in the

first six months, 33.62 per cent more than in the first half of 1936.

BROADCAST BONANZA

The drug and toilet goods industries invested \$6,610,632 in NBC time during the first half of 1937. Four others passed the million mark, food and food beverage makers spending \$5,607,660, the automotive industry \$1,752,069, laundry soap and housekeeping supplies manufacturers \$1,596,892 and producers of lubricants, petroleum products and fuel \$1,068,052.

Total time take from all classes of advertisers hit \$19,948,107.

WASHER'S BIGGEST

Household washer shipments in the first six months of 1937 totalled 949,328, 10 per cent above a similar period in 1936, according to J. R. Bohnen, secretary of the American Washing Machine Manufacturers' Association. This represents the biggest washer first half in history.

The ironer half-year nets 94,696 units shipped as compared to 88,044 in the first six months of 1936.

DEPARTMENTS AND CHAINS

Large department stores recorded an 11 per cent increase over 1936 in first-half, 1937 sales. Best increases came in

RADIO SETS IN THE WORLD

(According to the U. S. Department of Commerce)

UNITED STATES (Continental)	30,000,000
UNITED KINGDOM (Great Britain and Possessions)	10,000,000
GERMANY	8,200,000
FRANCE	2,626,000
CZECHOSLOVAKIA	928,000
BELGIUM	746,000
DENMARK	651,000
ITALY	530,000
POLAND	519,000
SWITZERLAND	430,000
HUNGARY	365,000
SOVIET RUSSIA	350,000
MEXICO	250,000
NORWAY	240,000
ROUMANIA	150,000
FINLAND	144,000
URUGUAY	115,000
IRISH FREE STATE	104,000
CUBA	100,000

Atlantic, Chicago and Cleveland districts.

Chain store sales increased 14.6 per cent in the same period, mail-order houses leading the parade. June increases averaged 11.7 per cent however, indicating a drop-back from the 15 per cent average gains reported in earlier months of the year.

FACTORY FIGURES

Arcturus reports that tube sales for the first 6 months of this year show a marked increase over the corresponding period of 1936, also marks a new high since 1929.

Presto Recording says its sales for the first 6 months were more than 2½ times greater than in the first half of 1936, has leased space in an adjoining building to take care of this volume and Australian and Latin American increases.

Half U. S. Farms Will Still Have No "High Line" Service in 1946

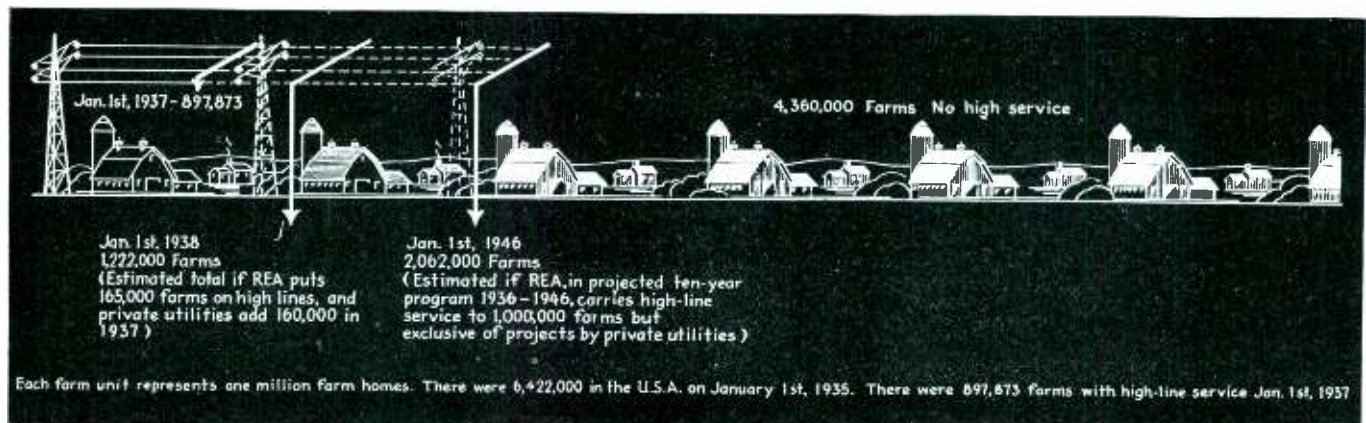



HUSBANDS & WIVES



In double-harness, real life as well as on the air, are these popular broadcast stars

AUDIENCE ONLY — Curiously, men and women who here air their domestic views are invariably "Husbands & Wives" while the conductors of this particular program, Allie Lowe Miles and Sedley Brown, are single

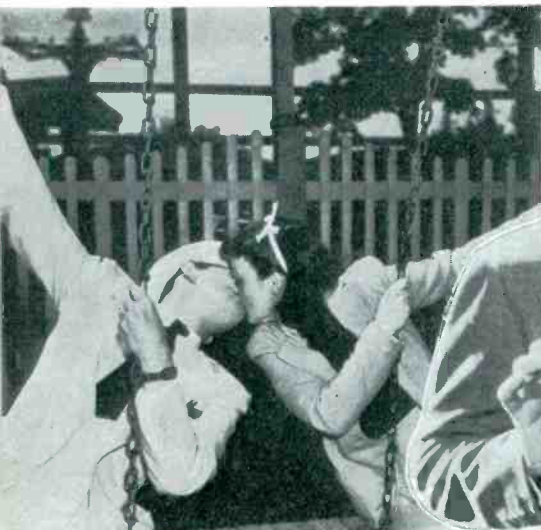

TIME SWINGS ON — John McIntire and Jeanette Nolan of the CBS "March of Time" program are really Mr. and Mrs.



BOTH BURNS — This popular couple, George Burns and Gracie Allen, dispense with the name Allen in private life



THREE OF THEM — NBC's Benny family, Jack, Mary and three-year-old Joan Naomi spend a quiet evening at home

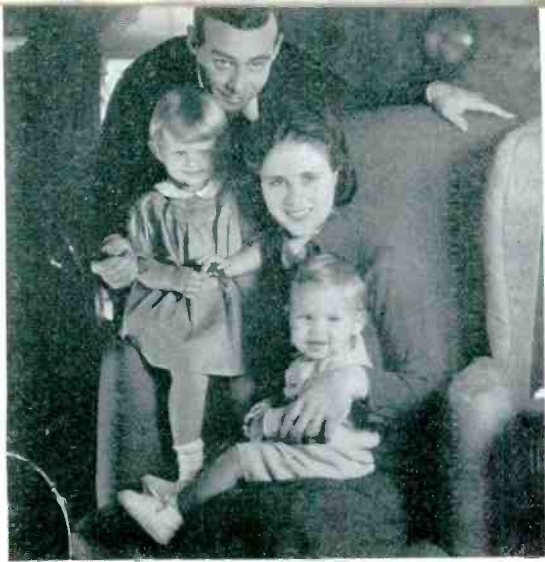

BAKERS ALL—At home, Mrs. Phil Baker's two children keep her plenty busy. She'll guest-star occasionally this winter via CBS



NOTHING BUT THE TRUTH—Anyway, when Fibber and Molly McGee of the NBC are at home as Marion and Jim Jordan



TWO ACES—Goodman sits across NBC's mike-equipped bridge table from wife Jane. Marge is the woman between but only on the air



LIFE IS A SONG—Frank Chapman and Mrs. Chapman regularly exercise their voices together over NBC. To listeners, the lady is Gladys Swarthout



TIM AND IRENE—On Mutual's "Fun in Swing-time" program, these two are both named Ryan, have been married some time



NO RESERVATION—Few listeners there are who don't know that squaw Portland Hoffa is married to big chief Fred Allen

COST ACCOUNTING

PROFIT and LOSS Statement

Service Department

1. DIRECT COSTS:

Cost of Sales (Parts and Accessories)
 Service Salaries and Wages
 Compensation Insurance (Service Labor)
 Service Advertising
 Service Data, Publications, etc.
 Shop Supplies
 Repairs To Equipment
 Insurance On Equipment
 Depreciation (Tools and Equipment)
 Bad Debts Arising From Service
 Other Direct Service Expenses
 Social Security Tax

2. AUTO EXPENSE:

Garage Rent
 Gas, Oil, Tires, Licenses
 Insurance
 Repairs
 Depreciation

3. OCCUPANCY:

a. Rent, Heat, Light, Power
 b. Furniture and Fixtures, } Insurance
 Maintenance
 Depreciation
 (Service Dept.)

4. ADMINISTRATION:

Rent, Heat, Light, Power
 Furniture and Fixtures, } Insurance
 Maintenance
 Depreciation
 (Office)
 Salaries (Clerical and Office Supervision)
 Compensation Insurance (Office Personnel)
 Legal and Auditing
 Stationery and Printing (Other than advertising)
 Office Supplies
 Postage
 Telephone

5. INSTITUTIONAL ADVERTISING:

A. Sales (Labor) Customers

B. Sales (Parts and Accessories) Customers

C. Sales (Labor) Internal

D. Sales (Parts and Accessories) Internal

E. Commission Credits (Internal)

F. Other Service Credits (Internal)

By **Russell B. Rich**

*The Wm. P. Squire Co.
 Pompton Lakes, N. J.*

THERE is no doubt that most of us retailers in the radio and electrical specialty field have not determined to a sufficient degree the separate results of our selling efforts and our servicing activities. Here within one business are two very distinct operations both of which should be made to pay their own way.

Upon the premise that service must not only pay for itself but must also show a satisfactory profit, it becomes necessary first to formulate some definite policy for apportioning income and costs based upon sound logic and with full consideration for all the facts surrounding our own particular shop.

Unfortunately, no exact standards for the industry as a whole can be laid down. But the following case study illustrates the fundamentals. It has been prepared for the store accountant rather than for the proprietor.

If the bookkeeping system now in use has been properly arranged the introduction of costing should be easy. Analyze the financial make up of the business, the nature of its income, operation and running expenses. Determine the most logical and accurate basis for allocating each type of expense and each source of income, subject of course to subsequent revision and correction. Then, reclassify the accounts in accordance with the cost policy formulated so as to breakdown service and sales factors as far as possible within the daily bookkeeping routine.

In a "Profit and Loss Statement—Service Department," as illustrated, the factors of service income and costs are to be picked up from the general accounting trial balance and closed into this service account at the end of the accounting period in the ratio that each has been determined to affect the service operation. Or—



KAUFMAN and FARRY

For the SERVICE DEPARTMENT

Intended primarily for the eyes of the radio dealer's accountant, this article tells how a retail store already maintaining an efficient bookkeeping system but combining figures on sales and service may readily determine what each department is doing separately

dinarily it is possible to group the general ledger accounts in much the same manner.

1. **DIRECT COSTS:** Under the revised account classification the general ledger should contain this grouping of direct service expense accounts, the balances of which are to be taken up entirely by service account. Included here is Cost of Sales (Parts and Accessories), meaning the cost value of all merchandise, materials, parts, accessories, tubes

used in servicing or sold to customers as a result of the servicing operation.

2. **AUTO EXPENSE:** Within the general accounting there may be required one, two, or three sets of these accounts. At any rate, the daily bookkeeping should charge off these expenses to cars used exclusively for selling (direct charge to sales department), cars used exclusively by service department and for sales installations and cars used jointly by both

departments. Split the latter and take up in service account a portion of this accumulation on the basis of mileage or the number of trips made for each department.

3. **OCCUPANCY:** (A) If both of the divisions are to be treated fairly a third element should be taken into consideration in apportioning expense "a" under this heading. It would seem that a three way split results in the most logical conclusion. A direct charge-off of one portion to sales, one to service and one to administration with the latter going into group 4 and thereby being absorbed by way of and in the ratio of the Administration allocation. Determining the basis or method of division calls for a clear, logical and impartial line of reasoning. The writer favors the following method of arriving at a reasonable figure:

Consider the total floor space, in square feet, as divided into three sections: (1) Selling floor, window, merchandise storage; (2) Repair section; (3) Office. Distribute the total occupancy over these divisions in as fair a ratio as possible on the basis of the square feet of floor space used and giving consideration to the relative value per foot of each section. As an example, a store thirty feet wide, 50 feet deep, and having a basement storage area of 300 square feet is under lease at \$150. per mo. Sales floor and window measure 30 x 30; service area 12 x 20; office 18 x 20; total area 1800 square feet.

One method of preparing this formula or to check if it has been prepared in some other way is to determine what the rent would be on the amount of space used for storage, service department and office separately if these functions were removed to appropriate locations from the ground floor on the main street. The remainder of the rent may be presumed to represent the ratio of

Dept.	Space Used	Value	Allocation	Per cent Total Occupancy
(1) Sales { Floor	900 sq. ft. @	\$.12½	\$112.50	75. %
{ Storage	300	.01¾	5.25	03.5
(2) Service	240	.06	14.40	09.6
(3) Office	360	.05	18.00	12.
Total	<u>1,800</u>	<u>\$.08½¢</u>	<u>\$150.15</u>	<u>100.1%</u>

occupancy chargeable as window and selling area.

(B) Furniture and fixture costs from one viewpoint anyway, may be treated as a natural consequence to occupancy. They differ, however, in being traceable to more or less definite locations within the establishment. By making one bookkeeping revision at the outset—simply breaking up the single Furniture and Fixtures account, transferring the balance to three separate accounts for—Sales—Service—Office—based on the values represented and the physical departmental location of each item, the distribution of all subsequent depreciation and maintenance charges has been simplified. Any reserve for depreciation existing at the time of the change-over should likewise be split in as near a relation to the inventory split as possible.

4. ADMINISTRATION: Into this classification comprising the general office running expenses a portion of occupancy has been brought down as explained above. There is no question that the office has served both departments and consequently the total expense should be allocated and absorbed against the income of both functions. In selecting the basis seek the method that most closely represents the actual conditions. Because of its simplicity and on sound theory, too, there is a tendency to resort to the percentage of sales ratio. But does this method in this instance record actual conditions? Compare the details surrounding a service job amounting to \$5.00 and a sale of \$100.00. Practically the same amount of bookkeeping, telephoning, statistical recording, etc., in each case. Therefore, the writer prefers to take up administration in the profit and loss accounts in the ratio of the number of journal vouchers, or journal entries recorded on the books, eliminating those representing office ex-

penses, and using the total of those affecting sales and service as 100%.

5. INSTITUTIONAL ADVERTISING: Publicity and newspaper space so designed as to "sell" the store, not mentioning specific merchandise may be charged off in the percentage of sales ratio within the accounting period. This method is a recognition of its direct affect on the business secured.

Cost Per Hour

At this point the total of profit and loss charges to service account has been developed. From job tickets, determine the total labor-hours actually consumed by servicing over the accounting period and divide into total charges, thereby arriving at the total cost of service per labor hour. The need for this will be explained later.

Take up as income credits total service sales to customers represented by balances of A and B.

Accounts C, D, E, and F are interdepartmental and carry as departmental income the charges made to the selling division either directly through cost of sales and expenses, or indirectly through merchandise inventory for services performed. Internal sales C and D comprise reconditioning, repairing, retouching and installation of new and used merchandise in inventory or in consummation of a sale and any free service in compliance with guarantees and other sales policies.

In the treatment of these internal "service sales" there is one important distinction. An outside service sale covers four elements—(1) labor, (2) material, (3) overhead at cost and (4) profit or loss on labor and material. Compounded, this amounts to labor (cost and profit), material (cost and profit), overhead (cost). On the other hand, an internal transaction recorded as a sale for cost allocation, not affecting the relationship

of the business with an outside factor, must be recognized as purely a method of transferring costs from one activity to the other. Conservatism demands that no unrealized profit be arbitrarily forced in this process of transferring.

Therefore, D will be built up at cost during the period as materials are removed from stock. C will be developed at the end of the accounting period so as to represent labor and overhead at cost on the basis of total cost of service per labor hour, using internal job tickets as the source of time information.

For example, presume that during the period total Service Account charges are \$657.00, job cards show a total of 450 hours of sold labor—425 of which have been billed to customers, 25 hours on internal service. Dividing total hours (450) into total charges (\$657.00)=cost of service per labor hour—\$1.46 x 25 hours=Sales—Labor—Internal—\$36.50. The offsetting charge to proper selling expense accounts causes selling to absorb a just portion of service costs.

Service account should receive credit (E) for any commissions accrued on sales of large merchandise for which it has been responsible. In the course of a service call the technician may be able to affect a sale of a new set. Ordinarily, the rate of commission to a service employee is much less than to a salesman. The regular salesman's commission less the amount actually paid to the serviceman may be taken up as an internal credit to service account.

No Extra Personnel

If the store's general accounting has been properly devised and adequate in the past the addition of this costing feature should be possible without any complications whatsoever and without any increase in personnel. All of the essential statistics should be developed anyway.

The largest task is the forethought and research required in setting it up properly, but the more care devoted to this end the simpler will be its operation. There are few establishments where its introduction will not show some very enlightening facts well worth the time expended.

By providing a basis for accurately pricing service and by isolating the losses that so often result from this end management is in a position to turn this expense burden into an income producer as well as to appraise the selling end purely on its own merits.

STEWART

Mystic Mechanism with Does What Nothing Else in Radio Can Do-

Here's a radio invention that makes even last week's new radios obsolete! A development that's utterly new—absolutely exclusive—that makes every radio owner a prospect again!

And it's not just another imaginary improvement or advertising claim—it's a reality that your prospects can see and operate and *believe!* A fine precision machine your prospects will agree is worth \$50 by itself—built into a superb radio—at a price you'd expect the radio alone to bring.

Don't confuse it with any tuner in other radios. It's different in every way—a genuine precision instrument made possible only by the combined resources of Stewart-Warner's radio and precision-instrument laboratories. And it's as far ahead of other tuners as the others are ahead of hand tuning.

SPLIT-SECOND SPEED! Goes directly—instantly—to the desired station. No slow travel to a switching point and back.

EASY TO SET UP! Keys are set from front—without tools—and any key can be re-set easily without disturbing others.

ABSOLUTE SILENCE! No hum—no between-station noise.

ENTIRELY AUTOMATIC! No hand-switching from manual to automatic tuning.

UTTERLY FLEXIBLE! Can be set for *any* 15 stations—in *any* order—regardless of frequency—and *all* 15 keys can be used.

ABSOLUTELY ACCURATE! Doesn't depend on A. F. C., which is used only as a safeguard against careless initial setting.

Available for any line voltage or frequency.

An Ideal, Automatic, Year-Round Station Log



The Magic Keyboard provides an ideal 15-station log. And every key can be used, because *any* number of the keys can be set to a *single* station. Thus all keys may be used for different stations—or a few may be marked by call letters, and the balance for individual programs. You can even mark the keys with pictures for tots too small to read—and a touch will tune in for them instantly, perfectly!

Easily Set Up—Saves Money for YOU!



Installation service won't steal your profits with this amazing invention, either. The keys are set from the front, without tools. You simply slip off the hand tuning knob, pull out the concealed setting control, and tune in the desired station for each button and the owners can re-set one key or more the same easy way, without disturbing the setting of the others!

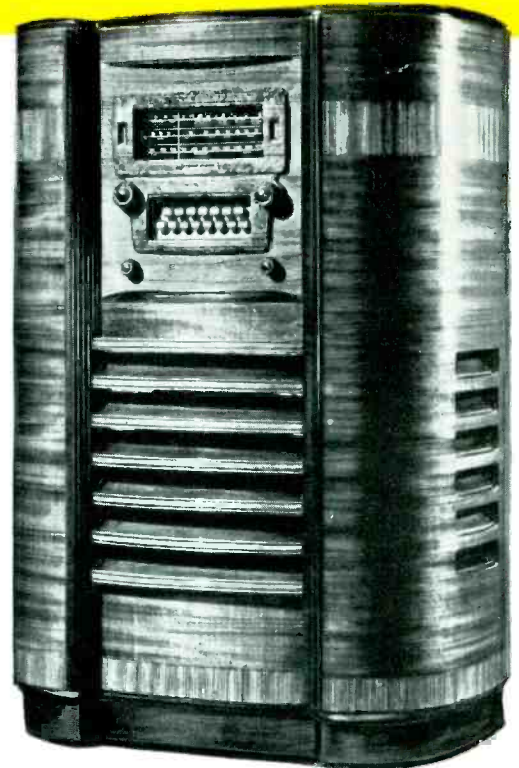

Model 1865—14 metal tubes—Mystic Mechanism with Magic Keyboard—Magic Dial—All-wave (525-13,100 kc.)—Visual Tuning Indicator—Hi-Speed Manual Tuning (spinner type)—12-Inch Copper Photo-tone Speaker—A.F.C.—Selectivity and Tone Controls—and all other worth-while modern features.

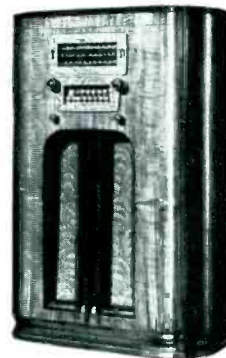

Model 1845—19 tubes—Mystic Mechanism with Magic Keyboard—All-wave (525-18,100 kc.)—Magic Dial—12-Inch Copper Photo-tone Speaker—A.F.C.—Visual Tuning Indicator—Spinner-type Hi-Speed Manual Tuning—and all other worth-while improvements.

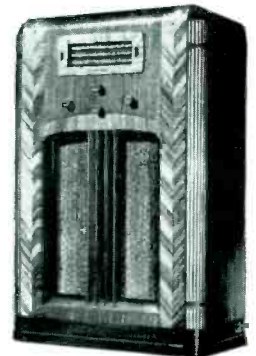

Model 1835—8 tubes—All-wave (525-18,100 kc.)—Magic Dial—Spinner-type Hi-Speed Tuning with 70-1 ratio—Visual Tuning Indicator—12-Inch Copper Photo-tone Speaker—Electron Beam Power Amplifier—Electrostatic Shield—and all other worth-while improvements.

ON PRECEDING PAGE—Model 1855—11 tubes—same features as Model 1845 described above.

WARNER

the MAGIC KEYBOARD

Offers Profit Power Nothing Else Can Equal

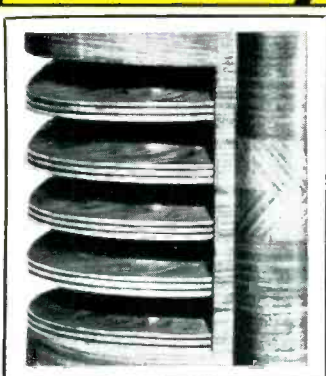

This distinctive grill style is a feature of several of the 1938 Stewart-Warner De Luxe models. It not only adds a new note of beauty to the cabinet, but acts to diffuse throughout the whole room all the beauty and richness which marks the tone of these radios. It's a feature customers will like.

AGAIN — EXCLUSIVE FINANCE PLANS THAT LEAD THE FIELD

Year after year, the outstanding record of Stewart-Warner products for "staying sold" has enabled us to arrange special finance plans with unusual advantages — exclusively for Stewart-Warner dealers. And we've done it again! This year it's the "add-on" contract, which enables any Stewart-Warner Refrigerator owner to finance a Stewart-Warner Radio by simply "adding-on" the radio to their existing refrigerator finance contract. This means no down payment — and special extended terms. It avoids any minimum on monthly radio payments — gives more time to pay — encourages new sales to present customers.

26 Distinctive Models Cover Every Price Level



AC-DC Model 1883—A top-quality AC-DC radio with 6 tubes—illuminated Magic Dial—Two Bands (540-1,720 kc. and 5.8-18.2 mc.)—A.V.C.—Full Variable Tone Control—8-Inch Dynamic Speaker—in a superb modern arm-chair style cabinet.

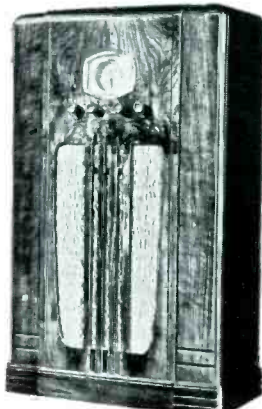

Model 1805—A console with real performance for the modest budget—with two tuning bands (525-1,750 kc. and 2,200-7,000 kc.)—8-Inch Dynamic Speaker—5 tubes—Automatic Volume Control—Tone Control—Code Rejection Filter—Electrostatic Shield.



Model 1833—Same powerful 8-tube chassis as Model 1835, described on preceding page—housed in a handsome arm-chair table with new tone-diffusing grill. Plate glass cover over controls slides into hidden well when radio is in use. A new radio style thousands are demanding this season.



Model 3043—One of three new lower-priced Stewart-Warner's designed to let you meet price competition at a profit. A beautiful, modern cabinet with 5-Inch Dynamic Speaker and 5-Tube chassis covering 540-1,720 kc. and including Automatic Volume Control.



Model 1821—Powerful 7-tube All-wave receiver—525-18,100 kc.—with Magic Dial—Visual Tuning Indicator—Automatic Band Indicator—A.V.C.—8-Inch Dynamic Speaker—Electrostatic Shield—Code Rejection Filter—and many other modern improvements.



Model 1811—Rich-voiced 6-tube all-wave radio—525-18,100 kc.—with Magic Dial—Visual Tuning Indicator—Automatic Band Indicator—A.V.C.—Tone Control—6-Inch Dynamic Speaker—Electrostatic Shield—Code Rejection Wave Trap—and other improvements.

Again! This Famous Orchestra Will Make
Actual Sales for You - With Coast-to-Coast Broadcasts for

STEWART WARNER



If you were on the inside last year, you know how Horace Heidt and his famous Alemite Brigadiers made actual sales of Stewart-Warner Radios for you. You remember how this wave of sales rolled even higher during the past refrigerator season when this same crew went to bat for you on a nation-wide radio hook-up.

So just let your own judgment tell you what's bound to happen when this great crew swings into its third radio series this

fall, with radio's greatest invention to add power to their selling.

Here is one of America's most popular radio dance bands—with millions of fans and followers—on a Coast-to-Coast Columbia network—selling for you. When they start telling hundreds of prospects around your store about what you have to sell, things are bound to happen. These programs will send prospects to you already sold.



PLUS The Most Powerful Advertising and Merchandising Plans in Our History

Of course, Stewart-Warner's national advertising is only the spearhead of the selling drive. We've stepped up the power of every part of our promotion—included more and better selling aids for every purpose.

Newspaper ads, literature, banners, every help you need is ready to start pulling in sales and profits. Shown here is the new, eye-catching DeLuxe store or window background. There is also a special illuminated animated display that explains the new Mystic Mechanism—and actually helps close the sale.



For Farm Homes, Too! — Battery and FREE-WIND-POWER Models



6-VOLT BATTERY MODELS 1921 and 1925
—All-wave (540-18,200 kc.)—6 tubes—Lighted Magic Dial—Precision Station Selector—A.V.C.—Permanent Magnet Dynamic Speaker—Lamp Outlet. No B or C Batteries are required.



2-VOLT BATTERY MODEL 1905—Two Bands (540-1,720 kc., 5.7-18.2 mc.)—Magic Dial—A.V.C.—8-Inch Permanent Magnet Dynamic Speaker. No C Battery. Same chassis is also available in table model.

6-VOLT BATTERY MODEL 1911—5 tubes—540-1,720 kc.—Same features as Model 1921. Also available in console.

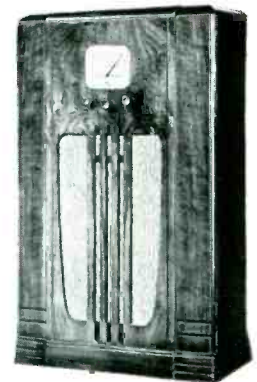

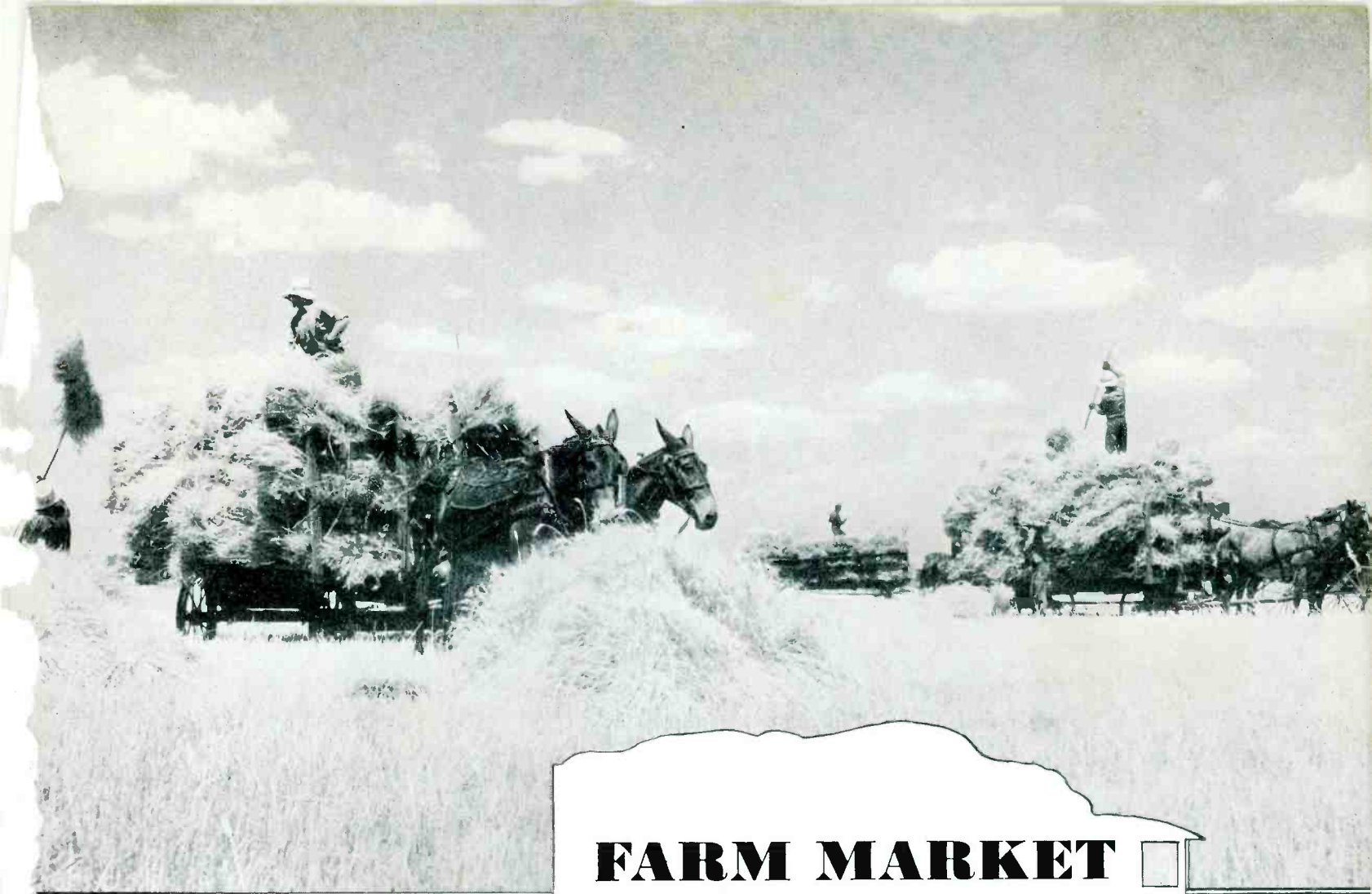

FARM MARKET FACTS

Why Rural Radio Sales Should Boom In 1937...

Every farmer needs and wants a radio to get crop-market-weather reports

Farmers have more money with which to buy radios than at any time since 1929

Prices for all classes of farm products are this year 24 per cent above the pre-war average and 17 points above 1936

Corn is selling at \$1.17 a bushel where it brought only 61 cents a year ago, and crops are much bigger

Back in 1933 it would have cost 250 bushels of corn to buy a radio, while at present prices 65 bushels will pay for one

Hogs put nearly 10 cents per pound into the farmer's jeans this year where last year 8½ cents was tops

In 1933 it took ten hogs, weighing 200 pounds each, to pay for a \$75 radio while today it takes only four hogs, same weight

Wheat brings nearly \$1.10 per bushel this year compared to 80 cents last year and many farmers are having bumper crops

If your prospect is a dairy farmer, tell him that with the 350 pounds of butter fat that it took in 1933 to buy a \$75 radio he can now buy the radio, a gas or wind charger and batteries to boot

The total income of farmers this year is expected to top last year's total by nearly 1½ billion dollars

The LOW-DOWN on HIGH-LINES

By D. C. Frederick

THE spotlight is turned full blast on the farm market. Every dealer who operates in or adjacent to rural areas knows it. Every distributor and manufacturer knows it. Every farmer knows it.

With bumper crops choking the highways and railways in some sections, in others big crops and good crops a certainty, with wheat, corn, hogs and other farm products all along the line—bringing high and profitable prices—it could not be otherwise.

Retailers in practically all lines have felt the upward surge of farm buying wherever their location enabled them to come in for a slice of the farmers' dollar. The automobile maker, the farm machinery and tractor men, the farm outfitters and fencer-iners and the lightning rod sellers, all have been cashing in. Even pianos, trombones, saxophones are piling up new sales records in rural areas, yet—*radio set and accessory sales seem to be lagging behind, lagging woefully in fact.*

What is the reason? Where is the snag? What constitutes the proverbial monkey wrench in radio's farm selling machine? Sales managers didn't know. Bankers claimed not to know. Nobody had a satisfactory answer.

So "Radio Retailing" decided to find out.

Mis-Information Widespread

Dealers and farmers were consulted in agricultural areas from Maine to Minnesota and from Michigan to Mississippi and when all the answers were in and sifted down to

their final significance they traced the pattern of just one shadowy cause for radio's lag, namely, mis-information about RURAL ELECTRIFICATION.

The long and the short of the whole situation was that farmers, hundreds and thousands of them, were sitting tight on their pocketbooks when it came to radio because they had visions of getting "high line" electric current tomorrow—next month, or—surely next year.

They thought they had read in their papers or heard it said that the huge government program of rural electrification would soon have a high line passing every farm house in the country. If they had an antiquated battery set, they proposed to keep on using it until the high line arrived and then buy a "regular" plug-in set. If they had no radio they would be "gosh darned" if they were going to buy a set and batteries and chargers and other gadgets, if pretty soon the high line came and they'd have to throw it all away.

Literally millions of farmers' dollars that rightfully deserved to roll into the cash registers of radio dealers either were being spent for other things or have been lying idle in banks, socks, tin cans or coffee pots.

Radio dealers needed a new selling tool, a special spotlight of facts. They needed the real truth on rural electrification so that they could explain to their rural customers the actual status and the prospects for high line service in any given territory.

The accompanying map is intended to serve as that much needed selling tool, while in this article and elsewhere in this issue additional au-

(Please turn to page 55)

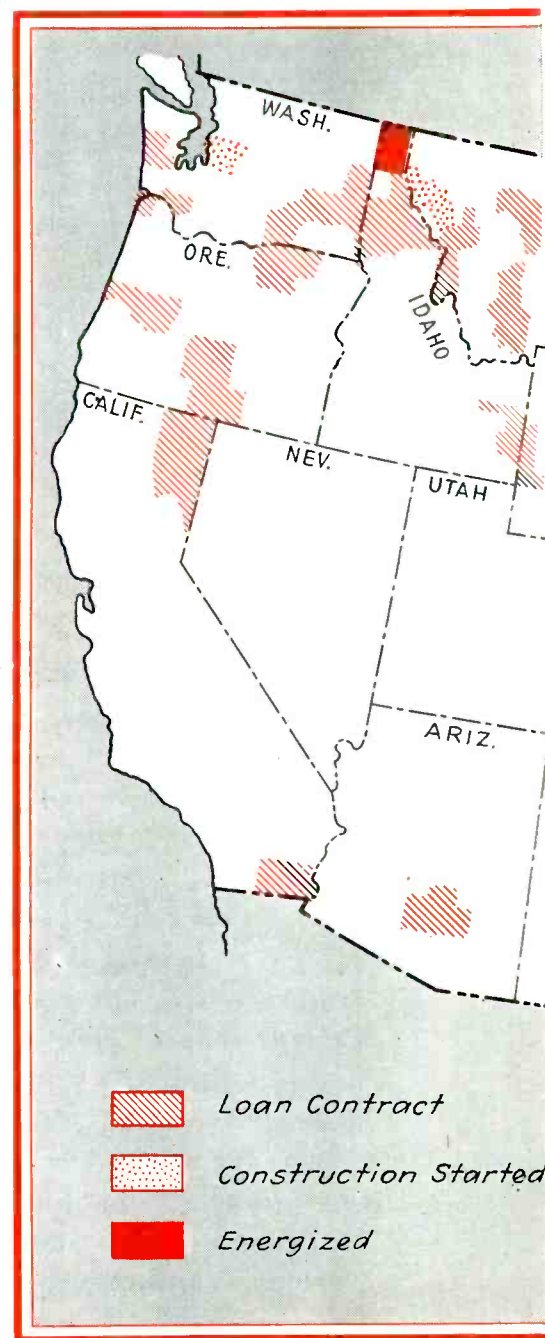

If the government's ambitious 8-year rural electrification program is carried out without political interference, if economic conditions permit expansion by private utilities at the rate now optimistically planned, 1945 will still find more than 4,000,000 farms without such service

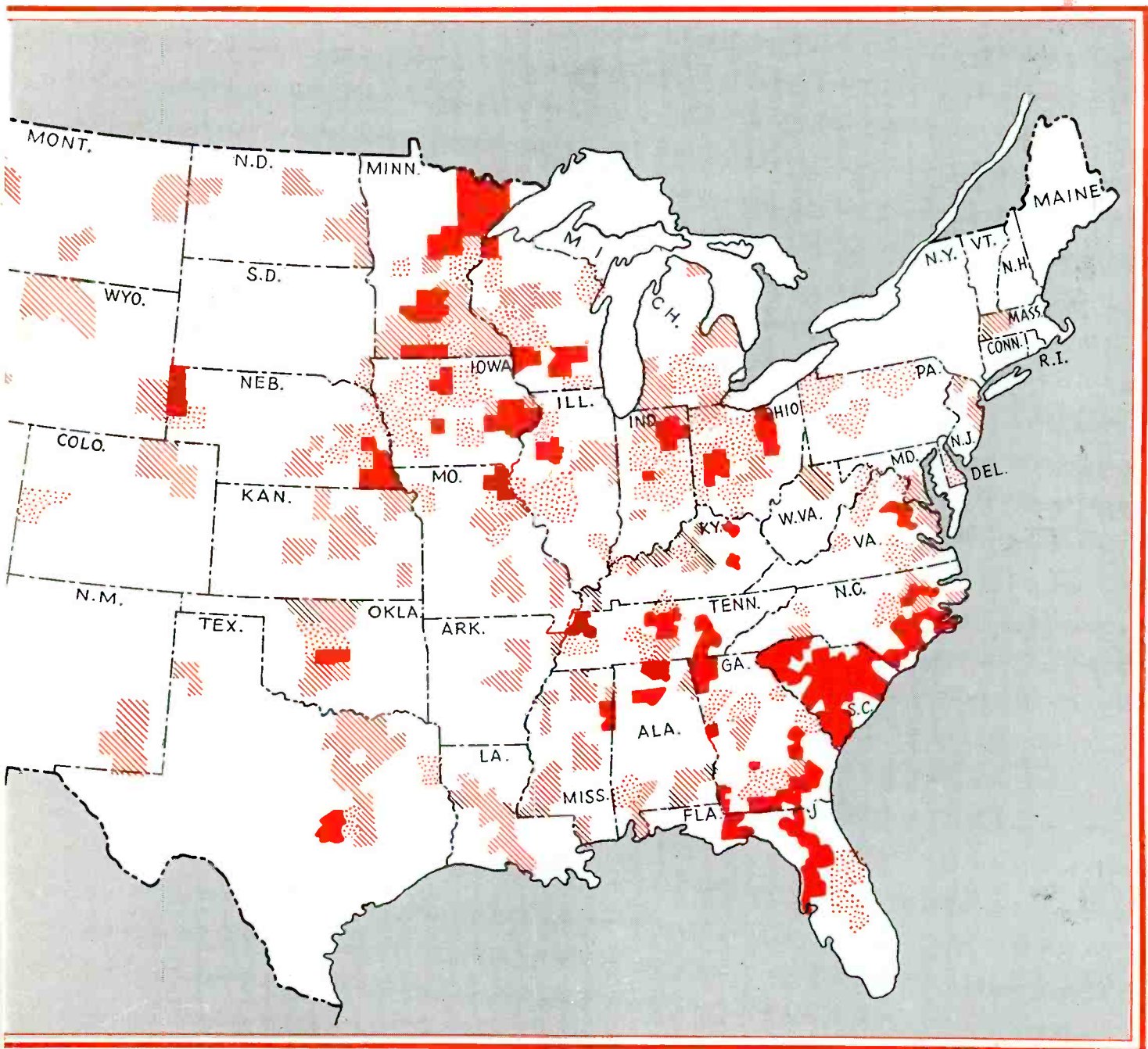

GOVERNMENT POWER PLANS—Prepared July 1, 1937 and complete as of that date, this map shows at a glance the accomplishments and projects of the

Rural Electrification Administration. Lines maintained or proposed by private utilities are not included.

P O W E R

To Suit The Purse

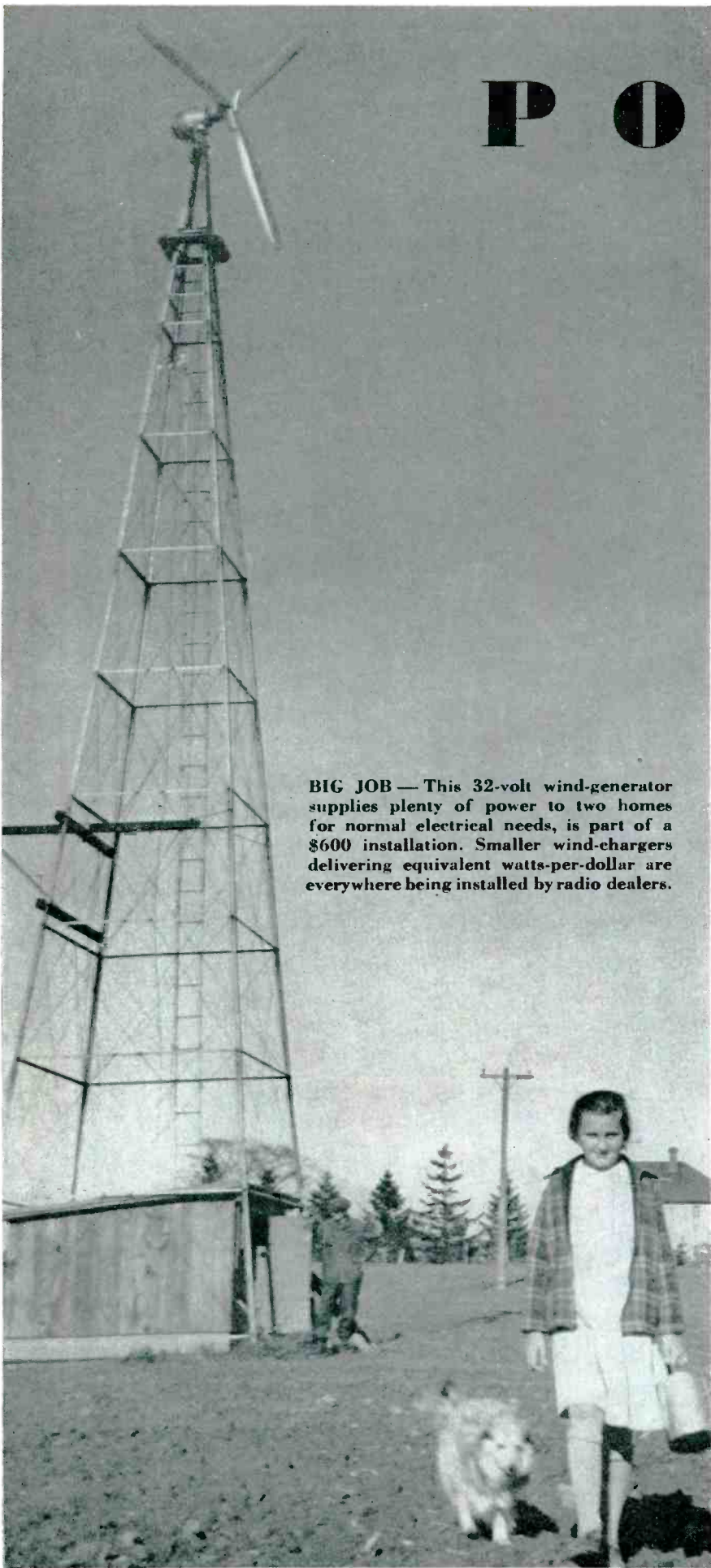

BIG JOB — This 32-volt wind-generator supplies plenty of power to two homes for normal electrical needs, is part of a \$600 installation. Smaller wind-chargers delivering equivalent watts-per-dollar are everywhere being installed by radio dealers.

THE gentleman at the adjacent desk, does not believe in small wind-electric plants. Nor does he appear to be enthusiastic about tiny gasoline chargers and generators. "Fly-power toys," he mutters, dismissing them thereafter from his mind.

Somehow, I feel that he and a lot of rural radio dealers could find a moral in Clem Hawley's operations at the time of the 1913 Anthony Fair. Clem pitched a hamburger stand smack-dab in front of the Bennett House. "A whole hog and a pickle for a nickel!" he bawled, and darned if he didn't have a hundred farmers munching away to every one who went into the restaurant and laid down 35 cents for its table d'hote lunch.

Obviously, small wind and gas generators will not run electric ranges, will not drive heavy machinery motors, will not completely substitute for high-line power or elaborate individual plants. But they do permit ruralites to have some of the electrical conveniences hitherto available only to the city brethren or their wealthy neighbors at a price within their means. It is surprising, too, what some of these small installations can do.

Take the average wind-charger, for example. The device itself costs about \$20. A 6-volt battery costs about \$8, lasts at least two years. Tower, heavy feed-wire, sockets and switches, can be obtained for about \$20. So for a total of less than \$50 the farmer can run a radio fully the equivalent of anything available to city-dwellers, light a few lights, even run a small electric fan of the type used in automobiles.

Still huskier wind-chargers are appearing on the market, so that more

Today's wide variety of wind and gas-driven generators opens the door wide to rural appliance sales

By Tom Blackburn



LITTLE JOB—Built into a new gasoline-driven washer, this generator charges farm batteries. Gas-driven generators turning out 6-volts d.c., or 110 volts a.c., or both, are available with outputs as low as 75-watts, as high as 5,000

RADIO FIRST (Upper Right)—Item with the greatest sales appeal to the farmer, radio naturally comes first after the installation of any kind of a power generator

APPLIANCES NEXT—After the radio, all kinds of electrical appliances are readily sold. In this instance the generating system is husky enough to handle an iron



lights and low-drain appliances can be added. Prices, even on these heavy-duty jobs, are still within the average farmer's means.

Gasoline chargers turning out about 100 watts sell for \$33.50 and up, keep radio batteries full, run 8 to 10 lights in addition. 200-watt gas generators are available at prices still within reach and are frequently equipped with 110-volt a.c. windings in addition to 6-volt d.c. output intended primarily for charging.

Latest wrinkle in the gas charger business is the inclusion of 6-volt charging generators in gasoline powered washing machines. Batteries may thus be charged while the laundry is being done and the washer motor may even be used in most instances for charging alone without exceeding the bounds of economy.

Nor need farmers limit their purchases from radio dealers to small wind and gas driven units of the type described above. A number of

manufacturers distributing equipment largely through the radio trade now have developed 32-volt wind generators turning out sufficient current to light an entire house, run nearly every kind of appliance the user needs, with the possible exception of heavy drain devices such as electric ranges, heaters, ironers and huge work motors. Such devices can be used to keep 32-volt storage battery banks up more economically than some of the gas

(Please turn to page 59)

POWER AND SERVICE TABLE, 6-VOLT BATTERIES

Amp. Hr. Capacity 100 Hr. Radio Rate	DISCHARGE RATES											
	5.65 Watts	8.47 Watts	11.30 Watts	14.12 Watts	16.95 Watts	19.77 Watts	22.60 Watts	25.42 Watts	28.25 Watts	31.07 Watts	33.90 Watts	37.72 Watts
	1.0 Amp.	1.5 Amp.	2.0 Amp.	2.5 Amp.	3.0 Amp.	3.5 Amp.	4.0 Amp.	4.5 Amp.	5.0 Amp.	5.5 Amp.	6.0 Amp.	6.5 Amp.
	Assuming that radio is operated 5 hours per day, the figures below represent the number of hours battery will supply current before requiring a recharge. To determine number of days of operation before the battery will require a recharge divide the respective hour ratings by 5. For maximum life, the battery selected should have sufficient capacity to operate receiving set for the number of hours, indicated by the bold-face figures, or the lighter figures to the left.											
100.....	100	66	49	38.5	31.5	27	23.5	20.5				
120.....	120	78	58	46	38	32	27.5	24.5	21.5	19.5		
150.....	150	99	73	58	48	41	35.5	31.5	23.5	25	23	21
180.....	180	117	87	69	56	47	41	36	32.5	29	26	24
300.....	300	196	144	114	94	78	63	60	54	48.5	43.5	40.5

Prepared by Globe-Union, Inc.

FACTS ABOUT BATTERIES

BECAUSE batteries have quietly, efficiently served the public in many ways for many years . . . in cars, in flashlights, on bells . . . the average consumer (and frequently the dealer) is inclined to take them very much for granted. Few users of rural radios realize that largely upon their selection of batteries designed specifically to run receivers rests reliable, convenient and economical service.

This is particularly true of storage "A" batteries labelled "For Radio" because many of these, in external appearance, closely resemble types intended primarily for use in automobiles. And yet, there is a world of difference in internal construction—

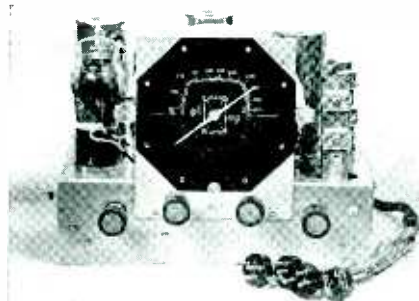

NEW CONNECTORS—Cables equipped with moulded plugs not unlike tube bases, fitting similar receptacles in today's "B" batteries, speed up replacement, completely avoid the chance of improper connection

Automobile storage batteries have *thin* plates, essential for high starting capacity. They will not have satisfactory long-life when discharged at a relatively slow rate, hence they are unsuitable for home radio operation. Radio storage batteries have *thick* plates designed expressly to render long service when discharged at a slow rate. They are unsuitable for use in cars.

CARDBOARD CASE—This new collapsible container, available to the consumer at slight cost, neatly holds both "B" and "C" batteries



"FOR RADIO USE"—The consumer saves money in the end by insisting upon thick-plate storage batteries of both 6 and 2 volt types, designed for long life at a steady, low drain. "Air-Cells" and dry "A's" made expressly for radio are similarly much more efficient than batteries intended for automotive and other uses



Even when purchasing the recommended, thick-plate radio battery it is most economical in the end if the customer obtains one with as much ampere-hour capacity as his pocket-book will stand. For, according to storage battery engineers, life may be roughly calculated in cycles (complete discharges and charges). Under normal operating conditions batteries having from 100 to 200 ampere-hour ratings (6-volt varieties in average radio service) will operate effectively through approximately 100 cycles. Types rated at 300 amperes or thereabouts will stand about 200 discharge-charge cycles. Heavy-duty batteries with still greater reserve capacity, frequently encased in glass-jars, will stand 300 or more discharge-charge cycles.

Obviously, the bigger the battery's reserve capacity the less frequently it will require charging. And fewer cycles, as explained above, mean longer battery life. Reserve capacity is especially desirable when batteries are used in conjunction with wind or gas chargers and is essential if lights

(Please turn to page 56)

March to Profit with

KADETTE!

**EVERY MODEL
A
KNOCKOUT!**

Kadette leads the industry with the greatest line of radio values ever produced. Sensational in beauty—sensational in quality—sensational in price, the 1938 Kadette models are the World's Best Value!

Model K-1019—AC Superheterodyne, new QAVC circuit, dual power output, oversize speaker, beautiful walnut finish cabinet. Tunes standard broadcast, all police and 49 M. foreign bands.

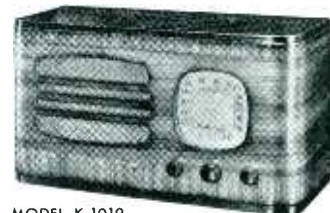

MODEL K-1019

10 tubes \$19.95

THE COMPLETE LINE — \$10.00 TO \$59.95

For Kadette dealers the 1938 line will bring the biggest profits in radio history. Leading this Value Parade are the phenomenal K-1019 with 10 tubes for only \$19.95; the K-1129 with 11 tubes for \$29.95; and the magnificent 11 tube console for only \$49.95.

Model K-1129—AC Superheterodyne with automatic volume control, high sensitivity, variable tone control and push-pull amplification. Tunes broadcast, amateur, airplane, police and 49 M. foreign bands.



MODEL K-1129

11 tubes \$29.95

COMPACT • CONSOLE • TABLE • CHAIRSIDE MODELS

Kadette dealers have the complete line—a radio at every price—for every purpose—for every decorative plan. Included are beautiful woods in exquisitely matched grains, distinctive plastics in every pleasing color combination, with compact, table, console and chairside models.

Model K-1149—AC Superheterodyne with push-pull amplification and variable tone control. Beautifully grained walnut piano finish console. Oversize speaker, full vision dial. Tunes broadcast, amateur, airplane, police and 49 M. foreign bands.

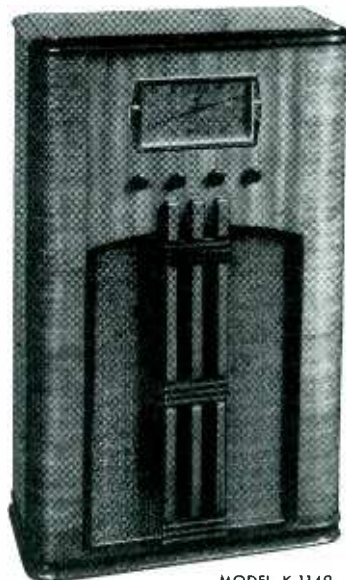

MODEL K-1149

11 tubes \$49.95

GORGEOUS WOODS AND COLORFUL PLASTICS

The Jewel in Brown Bakelite—\$10.00

The Dynamic Jewel in Walnut Bakelite, Ivory or Red Plaskon—\$13.50

The De Luxe Portable in Walnut or Ivory—\$22.50

The Clockette in four color selections of Crystalin—\$29.50

The Classic in seven color combinations of Bakelite, Plaskon and Tenite—\$29.50

Model K-617, AC-DC 6 tube superheterodyne—\$17.95

Model K-1024, 10 tube AC superheterodyne—\$24.95

Model K-634, 6 tube AC superheterodyne with 17 to 55 M. short wave—\$34.95

Model K-739, 7 tube, all wave AC superheterodyne—\$39.95

Model 649X, chairside model with cocktail cabinet—\$55.00

Model K-1159, 11 tube AC superheterodyne with massive 40" console—\$59.95

KADETTE DIVISION

INTERNATIONAL RADIO CORPORATION

WILLIAMS STREET

ANN ARBOR, MICHIGAN



SOUND ON A SHOESTRING

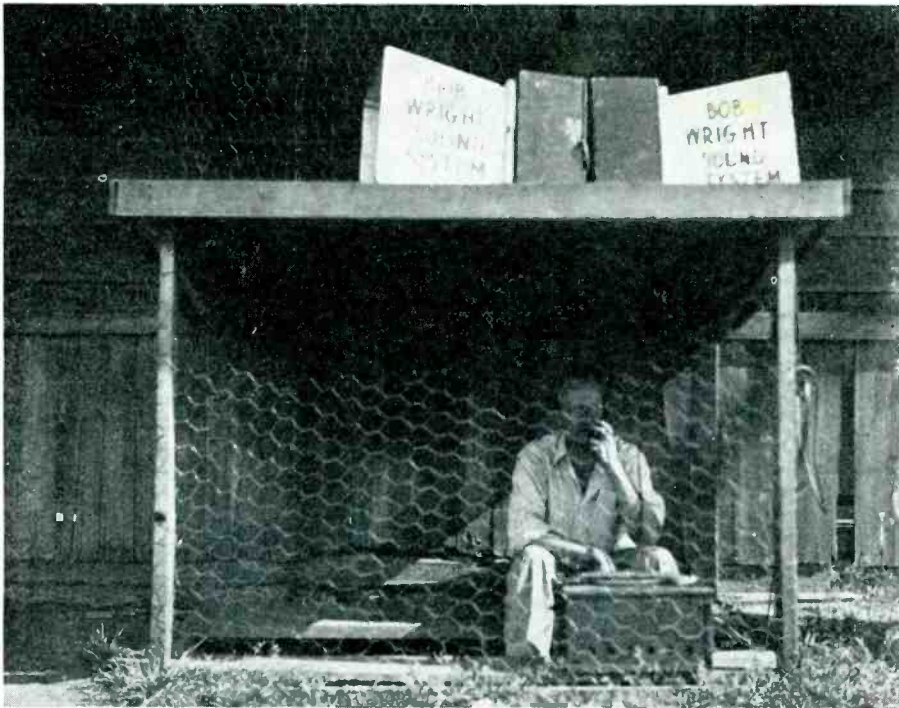

FIRST JOB—Bob's boss sponsored the local soft-ball team, and Wright induced the Jack Sprat food factory's local dealer to pay for an initial advertising experiment

IF you have a desire to go into Public Address work, even though you have no equipment, no car and not much extra money for new ventures, don't give up. It can be done. In fact, I've *done* it and P.A. as a sideline is now paying me \$300 a year.

Two years ago I got my first taste of the business. The man I worked for sponsored a soft-ball team and its first major game was with the Jack Sprat team from Marshalltown. It so happened that I traded at the local Jack Sprat store so I asked the dealer if he would pay \$5 for spot announcements about his products. The answer was "OK," so I contacted a man who had an amplifier used at a skating-rink in winter, made a deal to pay him 20 per cent of my takings for the loan of the equipment. I was to keep the amplifier in repair.

The manager of the local hard-ball team heard it at the soft-ball game and made arrangements to use it steadily thereafter. He helped line up sponsors and I cleared an extra \$50 on this job alone during the season.

This taste of P.A. work whetted

my desire for more and I decided it would be necessary to have a mobile unit if I wanted to expand. I contacted local theatres and asked them if they could use my services to ballyhoo some of their shows. I also contacted several automobile showrooms and obtained their assurance that I would be hired to ballyhoo new car models. With this assurance of work for an amplifier of my own I finally got up nerve enough to ask a local finance company if they would help me swing the proposition. The answer was: "Yes, 10 per cent down

(Please turn to page 58)



"Starting with a rented amplifier, using the customer's own car, later buying a mobile unit on time, I've built up a \$300 annual profit sideline in just two years."

says

BOB WRIGHT

Charles City, Iowa



MOVIES FALL—Ballyhoo for new "flickers" playing at a local picture house came next, still produces small but regular extra revenue

TIME ONLY—A special demountable speaker assembly (see *Service Section* for mechanical details) permits Bob to use the customer's car, eliminating the expense of gas, oil, repairs

THE

SUCCESSOR TO THE
WASHING MACHINE
IS HERE!



The **BENDIX HOME LAUNDRY**

Washes... Rinses... Damp-Dries... AUTOMATICALLY

**PUTS PROFIT BACK INTO
THE APPLIANCE BUSINESS**

A REVOLUTIONARY PRODUCT THAT BRINGS

SIMPLE...FOOL-PROOF



CONTROLS

Washing, rinsing and drying time cycles are controlled by a mechanism as simple and unfailing as an electric clock. Positive thermostatic control regulates desired water temperature... as accurately as temperature is regulated in refrigerators and for oil burners.



MOTOR...TRANSMISSION and PUMP

The electric motor is of the standard quarter horsepower type now used on washing machines. The pump is of the conventional design in common use for numerous purposes. The transmission principle follows closely that which is employed in present day motor cars in simplicity and dependability.



VALVES

The water inlet and drain valves are automatic and electrically operated... as simple as pulling a stopper out of a sink.



CYLINDER and TUB ASSEMBLY

The Bendix clothes cylinder is perfectly balanced on its ball-bearing axis and spins in the fixed tub as freely and smoothly as a top.



APPROXIMATELY ONE-HALF AS MANY OPERATING UNITS THAT MAY REQUIRE SERVICING

AMAZING PUBLIC RESPONSE AWAITS THIS SENSATIONAL LABOR-SAVING INVENTION

Actual showings of the Bendix Home Laundry proved that tremendous public response awaits this revolutionary successor to the washing machine. Women are bowled over by its sheer simplicity and miraculous performance.

At demonstration after demonstration, women were amazed... found it hard to believe... that such a simple machine could do seemingly impossible tasks *automatically*. But they believed their own eyes (as you will) when demon-

strators put in soiled clothes... set automatic controls... took out clean clothes, damp-dry... while Bendix did *all the work without attention*.

You, too, will be amazed... become enthusiastic over the possibilities of this astonishing new labor saver, that will change an entire industry. You will be eager to become a Bendix dealer and offer this modern miracle to the women of your community!

EITHER PORTABLE OR PERMANENT INSTALLATION

WORKLESS WASHDAYS TO WOMEN!

WHY WOMEN WILL REPLACE WASHING MACHINES WITH THE BENDIX HOME LAUNDRY

SAVES LABOR... Fully automatic operation . . . washing . . . rinsing . . . damp-drying . . . *without attention.*

BETTER WORK... Launders clothes better than by any other known method. All clothes washed in clean water and given three separate clean water rinses.

PAYS FOR ITSELF... Uses less soap, less bluing. Far less wear on clothes. Direct cash saving where day labor is employed for laundry work.

SAFE... Has no exposed moving parts, no wringer. A child can operate it.

TROUBLE-FREE... Approximately one-half as many operating units that may require servicing.

FULLY GUARANTEED... A full year's guarantee on parts and workmanship.

PROTECTS HEALTH... Laboratory tests prove that the Bendix Home Laundry washes clothes *sanitarily clean.*

FLEXIBLE... Washes sheer silks, rayons, lace curtains, fine linens safely, as well as thoroughly cleaning dirty work clothes. Takes just a few garments or a full load of nine pounds.

SELF-CLEANING... Bendix scours itself automatically without attention.

NO SET TUBS NEEDED... Bendix soaks clothes . . . pre-soaking optional . . . with agitation before washing.

REASONABLE PRICE, EASY TERMS... Easy to buy on long convenient terms.

HERE'S ALL THE WOMAN DOES:

PUTS
CLOTHES
IN

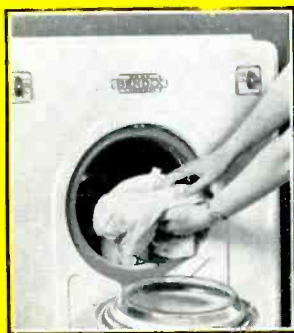

SETS
AUTOMATIC
CONTROLS



CLOTHES
READY
FOR LINE



BENDIX OVERCOMES ALL THESE OBJECTIONS TO WASHING MACHINES

NOTE: Answers by women to question . . . "What do you dislike most about washing machines?" . . . from a survey made in 10,000 homes.

Cleaning tub after washing

Lifting wet clothes

Running clothes through wringer

Cleaning wringer

Testing hot water by hand

Hand operations

Appearance

Boiling clothes

Soaking clothes

Take too much strength

Take too much time

Removing agitator or plunger

Do not get clothes clean enough

Removing agitator

Rinsing

Emptying dirty water

Take too much soap

Tangling clothes

Take too much water

Buttons break off during wash-

ing or in wringer

Removing of clothes from hot water

Turning wringer by hand

Putting water in tub

Extra scrubbing

Too much vibration

Hand wringing

Running up and down cellar steps

Catch hands

Extra rinsing

Too hard on clothes

Wringer tears clothes

Wetting hands

Lifting clothes to wringer

LIBERAL TRADE-IN ALLOWANCE

PREVIEW SOON of PRODUCT and MERCHANDISING PLAN

POWERFUL NATIONAL MAGAZINE ADVERTISING

Full color double spreads followed by full pages every month in *The Saturday Evening Post*, *Good Housekeeping* and *Life* will announce and pound home the story of Bendix to over 6,000,000 families . . . month after month.

The circulation of these great national publications parallels population from coast to coast. The higher income groups in your community read these magazines. And these people are the best prospects for the Bendix Home Laundry. They have the money to buy it. These advertising messages every month will smooth the way for your salesmen.



FACTORY-PAID NEWSPAPER ADVERTISING IN 96 CITIES plus LOCAL COOPERATIVE PLAN

Rotogravure and black and white half pages and quarter pages will smash home the Bendix story to over 12,000,000 families every two weeks. This advertising will drive hot prospects into your display rooms because this advertising will list Distributors and Dealers and carry a powerful action-producing hook.



HERE'S WHAT THE BENDIX FRANCHISE OFFERS SELECTED DEALERS

- 1 A product that revolutionizes the washing machine business.
- 2 The most generous discounts in major appliances.
- 3 One model, which means rapid turnover . . . greater profits.
- 4 No yearly models . . . eliminates obsolescence losses . . . creates greater profits per unit.
- 5 Longer gross dollar profit per unit sale than any other major household appliance.
- 6 Liberal trade-in allowance.
- 7 The most powerful advertising and sales promotion drive ever put behind an appliance of this kind.
- 8 The backing of one of the strongest and best known names in American business.

LOCAL ADVERTISING AND SALES PROMOTION

There's a generous plan for Cooperative Factory-Distributor-Dealer Local Advertising. Newspaper mats and cuts, radio records, signs, displays, literature, direct-mail . . . proved sales promotion material will be available. The Bendix policy will be the same as with the product itself. Quality first. Not how much, but how good!

YOU WILL BE INVITED TO A PRE-SHOWING OF PRODUCT AND MERCHANDISING PLANS

WATCH FOR AN INVITATION TO A PREVIEW OF THE BENDIX HOME LAUNDRY AND THE SENSATIONAL PROFIT-MAKING MERCHANDISING PLANS BY THE DISTRIBUTOR IN YOUR TERRITORY. GET SET TO GO!

WRITE FOR NAME OF DISTRIBUTOR IN YOUR TERRITORY

BENDIX HOME APPLIANCES, Inc.

528 FISHER BUILDING, DETROIT, MICHIGAN
DEPARTMENT R



FIRE—Cellophane, twisted in experienced hands before a microphone, sounds like the crackle of flames

MURDER—A knife, jabbed into a potato, sounds like a stabbing to the radio audience



FIGHT—Pounding a rubber sponge gives realistic blows when dramatizing the prize ring or a street brawl



SOUND EFFECTS

LEFT

MILK—Water filled ear syringes, squeezed rythmically into a bucket, are the studio cow



RIGHT

SUICIDE—Squash goes a squash and the listener pictures a plunge from a tall building



ABOVE

ARMY—Wooden pegs, dropped repeatedly on a table, duplicate the tramp of many marching feet

Photographed in the studios of NBC

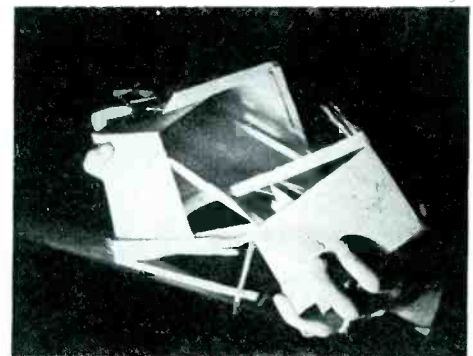

ABOVE

SMASH—A berry box, crushed thus, resembles the splintering of a door or breaking of a packing case

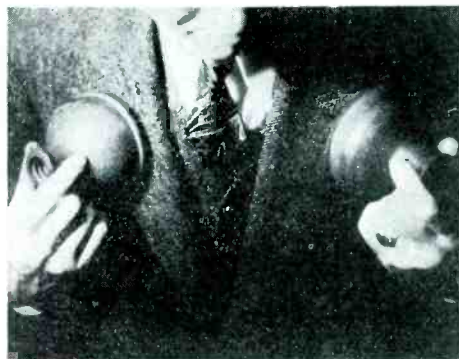

LEFT

HORSES—Two plumber's suction cups, pounded Tarzan fashion on the chest, simulate steeds on turf



PROFIT BY THE *Sales Appeal*
OF THE NEW 1938 ARVINS WITH THE
Phantom Filter Circuit



ARVIN Phantom Bachelor Model 628CS—6 tubes. A popularly priced chairside radio.

Above: ARVIN Phantom Girl Model 518A—5 tubes. • Below: A ARVIN Phantom Junior Model 613—6 tubes.

A complete line of distinctive radios with every modern improvement headed by Arvin's big dominant sales feature...

The Phantom Filter Circuit

The Arvin Phantom Filter Circuit means simply this: Better Radio Reception—because—it filters out noise—improves tone quality—increases station range—and clarifies radio programs. That, plus Arvin's beautiful cabinet styling and attractive prices, form a combination that wins sales and profits for you.

The new Arvin line is fired with sales appeal that's plenty hot—and with the nation-wide advertising, impressive merchandising displays and other promotional material available—you have a real opportunity to cash in on Arvin radios. See and hear the new Arvins... and ask your jobber about Arvin's sales-producing support.

NOBLITT-SPARKS INDUSTRIES, INC:
 COLUMBUS, IND. Also Makers of Arvin Phantom Filter Car Radios.

August

NEWS

Amplified Pianos Shown

Wedding of electronic devices with other musical instruments also noted at N.A.M.M. exhibit

NEW YORK—Predicted in *Radio Retailing's* July "Radio Month" page 7, several pianos utilizing tube-type amplifiers appeared at the July 27-30 convention and trade show staged as its 36th annual effort by the National Association of Music Merchants, Hotel New Yorker.

Among exhibitors of pianos and organs the following companies were obviously electronic-minded: Everett Piano Co. of South Haven, Mich., showing its "Orgatron"; Hammond Organ Co. of Chicago, with its already well-known instrument; Krakauer Bros. of New York, exhibiting an electronic piano; Meissner Inventions of Millburn, N. J., showing latest developments for electronic pianos, organs, guitars and amplified band instruments.

Further applications of the electronic art to musical instruments were seen in the Maas Organ Co.'s of Los Angeles use of amplified chimes; Epiphone of New York's cathode-ray instrument tuning device and amplified string instruments; National Bobro Corp.'s, of Chicago and Los Angeles, amplified guitars and mandolins, The Vega Co.'s, of Boston, guitars, mandolins and banjos equipped with double magnetic pick-ups, The Rudolph Wurlitzer Co.'s, of

DeKalb, Illinois, experimental inclinations.

Exhibiting at the show, also, were eight manufacturers of radios, radio-phonograph combinations, straight reproducing instruments and allied equipment. Ansley Radio of New York was represented by Arthur C. Ansley, Anne Klein Ansley, George P. Lohman and Henry J. Kelley. Capehart of Fort Wayne had I. C. Hunter, R. C. Vaughan and C. W. Emley on deck. Electro-Acoustic Products of Fort Wayne sent Frank Freimann, president, W. M. Lightbowne, J. H. McMullen, Daniel F. Doyle, E. P. Bliss, Jr. and V. J. Sanborn. Emerson Radio & Phonograph was represented by Nate Hast and Chas. Robbins. Philco had several rooms. Presto Recording of New York had R. C. Powell and T. B. Aldrich on hand. RCA was represented by H. S. Maraniss, E. W. Butler, E. Wallerstein and T. F. Joyce. Sonora Electric of New York sent H. W. Gerard, M. R. Benjamin and C. E. Denton.

Parts Show Plans Progress

Early booth contracts indicate strong manufacturer support

NEW YORK—From A. A. Berard, chairman of the Sales Managers Club, eastern group, and vice-president of the Radio Parts Manufacturers National Trade Show,



ELECTRONIC PIANO—Ben Miessner, to whom most engineers look for new ideas in this field, plays a few chords for us on a tube and amplifier equipped model built under his guidance, at the NAMM's shindig at the New Yorker



AT MUSIC SHOW—R. C. Powell of the Presto Recording Corp. (right) discusses a new \$149 portable record-maker with W. MacDonald, managing editor of "Radio Retailing"



GOLF AND CHICKEN—The Northwest Radio, Refrigeration and Appliance Association, organized in 1923 and the oldest of its kind in the country, staged a golf-game and chicken dinner July 22 at Westwood Hills, Minneapolis. Here are a few of the 100 men who attended

comes the news that the number of booths already contracted for at the show to be held at Commerce Hall, October 1-3, indicates manufacturer acceptance similar to that accorded the show staged by this group earlier in the year at Chicago.

Early reports from Ken Hathaway, managing director, indicate that parts jobbers, sales representatives, engineers, servicemen and amateurs from points all along the eastern coast plan to attend in force. Numerous reservations for rooms have already

been made at the Victoria Hotel, show headquarters located 10-minutes subway ride from the exhibit hall in the Port Authority Building.

At present, necessity for about 25,000 sq.ft. of exhibit space is anticipated.

"Nothing Down" Is Out

Furniture dealers urge initial cash payment on time transactions, limiting of terms to two years

CHICAGO—At the National Retail Furniture Association's semi-annual meeting here July 7, the following resolution was adopted:

"As a part of the process of 'priming the pump' in building back prosperity from the 1932 level, our Federal Government in 1933 and 1934 initiated financing and selling plans for electric and other home appliances on the basis of three and four years to pay. Inspired by such encouragement, manufacturers of appliances as well as distributors encouraged retailers to feature 'nothing down' and three years to pay.

"Such term offers have been given the public on electric refrigerators, electric ranges, water heaters and other large unit of sale home equipment.

"Widespread advertising of such overly liberal terms has encouraged selling of more types of home equipment as well as other items purchased by the consumer—on long-time instalment credit plans. With business developed far back from its depression bottom, present conditions do not justify such drastic stimulants. As a sound credit policy, when times are good, credit positions should be strengthened.

"Home furnishings retailers, members of the National Retail Furniture Association, through their scores of years in the instalment credit field, know that long-term credit in all kinds of home appliances is now being over-emphasized. The National Retail Furniture Association believes it is now time for all interests, manufacturers, wholesalers and jobbers, retailers, finance companies and advertising agencies to consider warnings given by various high officers of the Federal Government, by bankers and economists and business leaders as to the extent of the present up-trend in the business cycle.

"The Association further believes that such examination leads to the logical conclusion that appliance credit terms should be shortened to a maximum of two years.

"The National Retail Furniture Association further believes that a slogan now being widely used in the automobile business 'payments to fit your individual purse' can advantageously be adapted on a wide and general basis in the home furnishings trade."

C.I.T.

PRESQUE ISLE, ME.—The C.I.T. Corporation, national sales finance company, has opened an office here at 220 Main Street. T. W. Singleton, formerly at Rochester, N. Y., is manager.

RADIO PATH TO POLITICS—Pictured performing one of his endless radio experiments while the family looks on is James W. Morgan, proprietor of Birmingham's West End Radio Company, who on October 1 becomes one of the city's three governing Commissioners. With him into politics goes Eugene "Bull" Connor, who's popularity as a sports announcer also won a place on the Commission at the last election

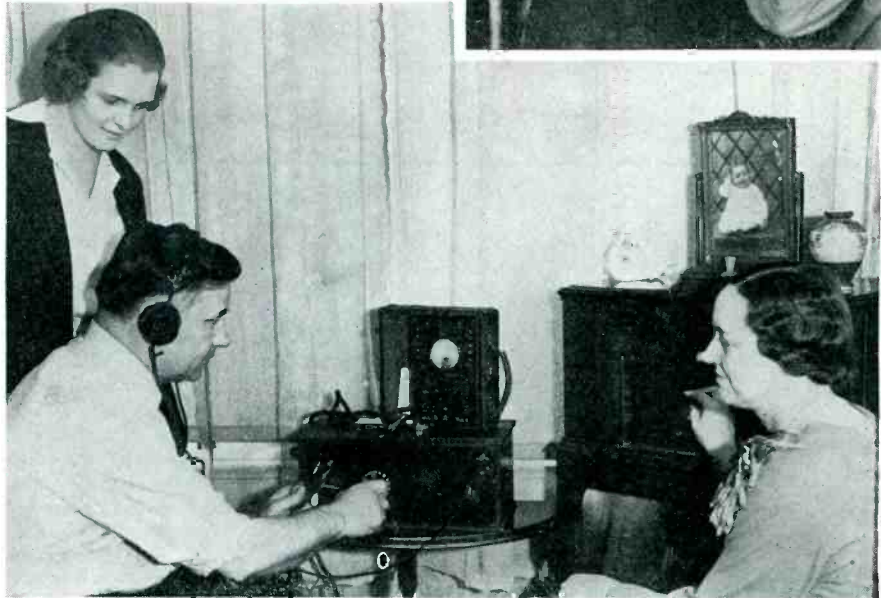

DOES IT WITH MIRRORS—Building up a sweet little set business with a pet cabinet idea that appears to have real dealer appeal is *Howard A. Pratt*, hard-working, conservative exec of New York's Pratt Mirror Glass Radios, 665 Fifth Avenue



SOUND IN THE DESERT—Emerson's French Moroccan distributor, Coriat & Cie., reported the progress of a 15-day cross-desert bike race recently, followed the race in the sound truck shown



SENTINEL AT CHICAGO—Here's a shot of the Sentinel Radio Corp's distributors, meeting at the Medinah Athletic Club. Rad-O-Fone, new combination radio and inter-communicator, made their eyes goggle

Texans Score "Spiffs"

New Fair Trade Code also sets standard for trade-in allowances

EL PASO—Trade-in allowances for old ice-boxes, commission-splitting, and discounts for quantity purchases are covered in the code of fair trade practices adopted by the Electric Refrigeration Bureau here.

Among the resolutions included in the code are:

Maximum allowance on old ice boxes shall be \$5 toward the purchase of an electric refrigerator whose delivered cash price does not exceed \$150, and \$10 on higher priced units.

Distributors and dealers shall not permit salesmen to share their commissions with customers, nor furnish wiring or outlets free to them.

A definite and fixed discount for all apartment houses and hotels shall be determined by the total number of units purchased.

There shall be a continuous exchange of retail price schedules to discourage false statements and eliminate misunderstandings.

Premiums of free merchandise shall not be offered as sales inducements except when included in national selling plans of manufacturers, and such practices should be discouraged.

Advertising and sales promotion methods are to deal directly with the merits of the product.

Dealers and salesmen are not to try to break down a sale after the order has been placed.

Derogatory statements concerning the financial standing of another product or manufacturer are deemed unethical, unbusinesslike, and detrimental to the industry.

New refrigerators are not to be rented.

Bureau members shall make a charge over and above the retail price when required to install one or more convenience outlets.

Distributors and dealers are to consult his former employers before employing a salesman with previous refrigeration experience.

Minimum finance charge shall be 6% for each year, and a fraction thereof at the

rate of $\frac{1}{2}$ % a month on the unpaid balance. A discount is allowed if cash is paid before termination of contract. Up to 90 days shall be considered cash.

Meissner Catalog

CHICAGO—The Meissner Manufacturing Company has just released a 32-page catalog listing coils of all kinds, describing receiver, remote control, phonograph oscillator, beat-frequency oscillator, noise-silencer kits. Included also are descriptions of new dials, switches, condensers and other parts and accessories. Available to readers of *Radio Retailing*, no charge.

Ariston Orders Up

CHICAGO—Heavy increase in demand for speakers and condensers is reported by "Wallie" Bauman, sales manager for the Ariston Mfg. Corp. The plant is now operating two shifts per day.



LITTLE ROCK LASSIE—*Norma Gunn* of W. B. Davis Electric tries out one of the first Sentinel combination radio and inter-communicators



TO EUROPE—President *Wesley M. Angle* of Stromberg-Carlson sailed July 21 from Montreal on the "President Harding", will visit Switzerland, Scotland and England, returning August 25



TO MAINE—*Dr. R. H. Manson*, Stromberg-Carlson's v.p. and chief engineer. He spent the month of July with Mrs. Manson at Spruce Point Inn, Booth Bay Harbor, polished up on his golf



MEALTIME FOR MANAGERS—Divisional sales managers of the Majestic Radio & Television Corp. convened at Chicago's Drake July 2, heard president N. L. Cohn (head of the table) outline aggressive merchandising plans for the next 12 months

Back On Feet

INDIANAPOLIS—Electronic Laboratories, Inc., this city, has successfully terminated a brief period of reorganization, emerging, according to president Norman R. Kevers, in a better financial condition than ever before, with a heavy increase in business over last year pointing to excellent future business.

Bakelite's Booklet

NEW YORK—The Bakelite Corp. of 247 Park Ave., announces release of a new booklet entitled: "The Versatile Service of Bakelite Materials," in which appears the story of development of various Bakelite resinous materials, their general characteristics, properties and applications.



REA ADMINISTRATOR—Snapped at his Washington office, *John M. Carmody*, Administrator of the Rural Electrification Administration, one-time editor of McGraw-Hill's *Factory Management and Maintenance and Coal Age*



MAN AT REST—*Brown of Parris-Dunn* relaxes at a Chicago hotel



ON THE RAIL—But its only a fence-rail. Besides, that brief-case means business. *A. E. Hoover*, manager of Electro-Acoustic's Chicago office

ON THE REA FRONT—

Construction contracts awarded by the government since July 1

GEORGIA

Thomaston, Upson County, 65 miles, 368 customers
Reynolds, Taylor County, 51 miles, 151 customers

IOWA

Vinton, Benton County, 187 miles, 500 customers

MINNESOTA

Anoka, Anoka County, 168 miles, 510 customers

MISSOURI

New London, Ralls County, 287 miles, 900 customers

MONTANA

Helena, Missoula and Ravalli Counties, 61 miles, 194 customers
Richland and other counties, 92 miles, 297 customers

NEW JERSEY

Newton, Sussex County, 126 miles, 321 customers

OHIO

Coshocton County, 122 miles, 370 customers
Morrow, Knox, Delaware and Richland Counties, 215 miles, 635 customers
Fulton, Henry, Wood and Lucas Counties, 160 miles, 400 customers

OKLAHOMA

Kay, Noble and Grant Counties, 282 miles, 740 customers

TEXAS

Hill, Ellis and Johnson Counties, 289 miles, 586 customers

VIRGINIA

Augusta, Rockingham, Shenandoah, Frederick and Page Counties, 357 miles, 1,511 customers

WISCONSIN

Taylor, Clark and Marathon Counties, 230 miles, 659 customers
Crawford, Juneau, LaCrosse, Monroe, Sauk and Vernon Counties, 505 miles, 1,575 customers



MINNESOTA MEN—From *James C. Pope, Jr.*, representing Triumph, Quam, Wirt, Muter DuMont, Brach and American Television and Radio, *E. W. Oszman* picks up a few pointers on these new lines



BRUNSWICK'S BLUE-STREAK—Into the appliance business comes Brunswick-Balke-Collender, with the "Blue Streak" beverage cooler as its initial electrical product. These are to be sold direct-to-dealer through the concern's 43 billiard-table distributing offices. *H. D. Laidley*, for 12 years with Chicago G.E., later a Portland, Ore. distributor, is department general manager



3-INCH RAY DISPLAY—*Leonard Cramer*, sales manager for the Allen B. Dumont Labs., is responsible for this hard-hitting display that sets off the firm's new oscillograph so nicely

Hinners Joins Fada

LONG ISLAND CITY, N. Y.—Frank Hinners, formerly of the Hazeltine Corp., has joined the Fada Radio and Electric Company as chief engineer, was appointed to this post July 20 by general manager J. M. Marks.

Hinners was with Fada in a similar capacity in 1930-32, resigned to associate himself successively with King-Hinners, Amrad, Bell Telephone and Hazeltine.

THE BEST "BUYS" ARE MADE FOR CASH!*

THE DEPRESSION'S
OVER—I'M BACK
BUYING RAYTHEONS
AGAIN!

RAYTHEON

* By "CASH" we mean your jobber's regular terms.

During the years when "sinking or swimming" was an everyday problem, a lot of business men, pressed for cash, got into "no investment" merchandise deals. One by one, most of them have fought their way back to sound business principles. And *only* by buying the *best quality* merchandise at *lowest possible* cash prices have they been able to prosper.

In the tube field, RAYTHEON offers the highest quality tube made—at cash* prices that save money for dealers every time they buy RAYTHEONS! That is why RAYTHEON business has more than tripled in the last two years . . . why RAYTHEON dealers are prosperous business men! Ask your RAYTHEON jobber.

THE AVERAGE DEALER INVESTS HIS MONEY IN RAYTHEON

7 TIMES A YEAR

SAVING HIMSELF 5% OR MORE EACH TIME

7x5%=35% SAVINGS BY BUYING RAYTHEON for CASH!

RAYTHEON

445 Lake Shore Drive, Chicago, Illinois
555 Howard Street, San Francisco, Cal.

420 Lexington Ave., New York, N. Y.
55 Chapel Street, Newton, Mass.

415 Peachtree Street, N. E., Atlanta, Ga.



Fairbanks-Morse Turret Shielded Radio, Model 9AC4

TURN PROSPECTS INTO CUSTOMERS

Visible plus-value features of Fairbanks-Morse Turret Shielded Radios turn lookers into buyers

Demonstrate *any* model from the 1938 line of Fairbanks-Morse Turret Shielded Radios to a prospect—and you will have made a *sale*. Some day, perhaps, all good radios will have features like those that make today's Fairbanks-Morse Radios sell on sight. But today, only Fairbanks-Morse offers them.

First—*Turret Shielding* and monitor base chassis, an exclusive Fairbanks-Morse development that shuts out much of the crackling and popping noise that ruins foreign reception on ordinary sets. Add to this the natural built-in ability of Fairbanks-Morse Radios to bring in foreign stations clear and strong, and you begin to realize what a demonstration of this feature means when the prospect is "on the fence"!

Second—the exclusive Fairbanks-Morse
The men who sold



Tone Projector that gives this radio new faithfulness and beauty of tone. Your prospects *see* what it is—*hear* what it does—like it—buy it and show it to their friends.

Third—today's finest development in *automatic tuning*—true automatic tuning with *true automatic frequency control*.

And that's not all. The Fairbanks-Morse 1938 Turret Shielded Radio has everything worth-while found in any radio—plus these and other sales-clinching features found in no other line.

No other radio makes as favorable an impression on the prospect as does a 1938 model Fairbanks-Morse.

Write for the complete story. There is a substantial net profit in it for you if your territory is open. Address Fairbanks, Morse & Co., Home Appliance Division, 2060 Northwestern Avenue, Indianapolis, Indiana.

them last year know!

FAIRBANKS-MORSE

1938 *Turret Shielded* RADIO

DISTRIBUTORS CONVENE WITH STEWART-WARNER



Stewart-Warner's *F. A. Hiter*. He made no speech



Gus Treffeisen (left) checks *John F. Ditzell's* figures indicating convention orders 300 per cent over last year, breaking all previous records



Exec *Fred Cross* tells distributors they have "enlisted for duration"



Backstage most of the time was *C. C. DeWees*



Perspiring, *R. S. Brunhouse* unveils the 1938 radio line



Making sure that *D. Harry Ellis*, Philadelphia Distributing, and *Rudy Browd* of Troy, N. Y., are happy, is *Ed Rutledge*

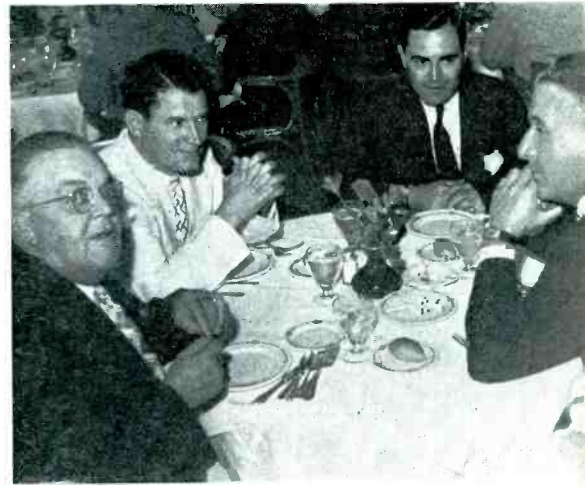

Prizewinners were *W. C. Duncan*, *L. M. Stratton, Jr.* and *M. O. Beckham* of Memphis' Stratton Hardware, here chatting with *Hays McFarland*



Sales honors were also awarded to *Joe Ramey* and *Joe Isaacman* of Monroe, La.'s *Monroe Furniture*, shown dining with engineer *C. R. d'Olive*



Behind the roses is *Oliver Shaw* of Charlotte, next to *Paul Richmond* of Kansas City



E. J. H. Reed, Jr. of Nashville; *D. M. Dupree* of Star Electric, Houston; hob-nob with *J. T. Neister*



Ed Rutledge, still circulating, says howdy to *Sam* and *Marty Salzman* of New York's *Wholesale Radio*

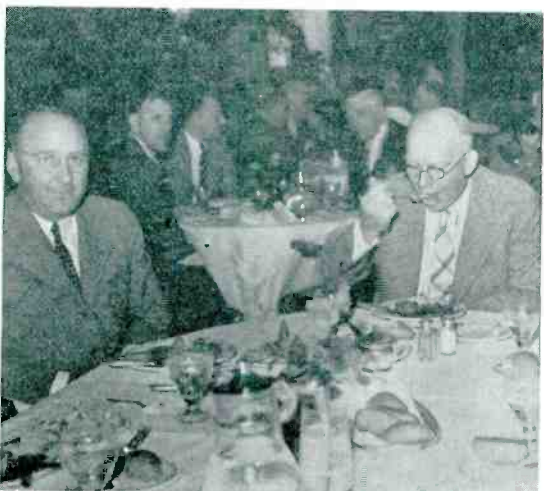

R. O. Quinn watches *R. G. Dorrance*, also of Pittsburgh's *Brown-Dorrance Electric*, eat



From the far west came *H. C. Parker* of Los Angeles' *Moore Electric*, *R. J. Lawrence*, *A. L. Willard* of Seattle's *Domestic Utilities*. Backs to camera, *L. M. Johnson* and *J. T. Granley* of Portland, Ore.



Cleveland was represented by *B. M. Kane*, *Marvin Kane* and *R. L. Bolch*, back to candidcamera



Saginaw was well represented by *Otto Schultze* and *L. E. Buetow* of *Morley Brothers*



B. Russel Barnes, *Art Newman* and *Clyde Peterson* of *Kelly-How-Thompson*, Duluth, obviously did not sit on their hands

International Springs Co-op

New division headed by Colin B. Kennedy to distribute line labelled "International" on cooperative basis to price-territory protected Distributors Research Group

ANN ARBOR, MICH.—To a selected group of radio distributors the International Radio Corporation has just extended an invitation to cooperate in the formation of an association to be known as the Distributors Research Group. Factory executives advise that this group is to participate in a new cooperative merchandising plan designed to overcome conditions threatening resale radio profits.

Distribution of a line of "International" radios, produced by a new company division under the direction of Colin B. Kennedy, is involved and it is understood that prices are to be such as to assure public acceptance while at the same time guaranteeing the trade a full margin of profit.

Important provision of the new distribution plan is International's proposal that both distributors and dealers participating be given exclusive territories, protected against future division of such territories or arbitrary cancellation of franchise.

The new line designed for distribution through the Distributors Research Group is, we understand, to be nationally advertised. Five models are already in production and more will be added as the Group finds these necessary.

C-B's College

Test instrument maker offers free short-course to users of products

CHICAGO—The Clough-Brengle Company of this city, effective immediately, offers free to servicemen purchasing its instruments a short-course of instruction covering basic principles of electronic testing, use of modern test devices.

Inclosed with each instrument is a registration card. Filled-in by the servicemen, such cards are forwarded to Midland Television, Inc., Kansas City school, bring no-charge lessons by mail.

Allied Expands

CHICAGO—The Allied Radio Corporation has just expanded its facilities to include an additional 10,000 sq.ft. of space in its building at 833 West Jackson Blvd. This is the second expansion in the last two years.

Farm Market Facts

SIOUX CITY—Wincharger has just printed for free distribution to dealers requesting it, a 32-page booklet entitled: "More Farm Radio Sales—And How To Get Them." In it, the farm market is analyzed, the Wincharger Corporation's part in this big business is explained, merchandising plans and displays are described.



5 CARLOADS—To set distributors selling Philco went 150 tons of Hy-Tower chargers valued at \$73,750 retail late in July from the Clarinda, Iowa, plant of Parris-Dunn. Mathes Company of Houston, Texas, took two complete cars



EXPORTERS EAT—Zenith men: John Brooks, secretary to Gene McDonald, C. V. Del Mercado and R. R. Robledo of the factory, G. M. O. Zumbano of Mexico City and James Weldon, export manager



FROM FOUR CORNERS—Key men in RCA-Victor's export setup, seated: John Miguel, Camden; Ricardo Espina, Caracas, Venezuela; M. Abramovich, Tel-Aviv, Palestine; J. M. Regottaz, Camden; Juan Castro, Havana. Standing: Guy Henneton, Paris; John Horton, China; E. C. Grimley, Canada; W. J. Avery, International Div. merchandise manager, Rogerio Azcarraga, Mexico City; Carlos Touche, Mexico and Ovid Riso, International Division ad manager

OVER A YEAR AGO

Admiral

Electric
TOUCH-O-MATIC
tuning

& MANY OTHER features!

THE last word in truly automatic tuning. Now . . . just touch a button . . . and presto! . . . in comes one of your favorite stations as simply and swiftly as switching on an electric light. The actual tuning is done by a tiny electric motor. Full vision rectangular dial with bands arranged horizontally permit easy reading. All calibrations are etched on a rich gold background and clearly indicated by moving ACRA-pointer.

Other outstanding Admiral features include full size dynamic speaker, automatic volume control, automatic frequency control, bass intensifier control, and many others.

Remember—Only Admiral gives you “tilt-tuning” plus electric “Touch-O-Matic” Tuning

Note: Admiral “Tilt-Tuners” are fully protected by patents. All Models RCA, Hazeltine and Latour licensed.





Goodbye SAID TO BACK BENDERS



TILT TUNING *is here!*

It was really new last year when Admiral first said goodbye to "back-benders". No more "daily dozen" every time you bring in a different station. Standing or sitting the tilted dial is tuned in a jiffy. Easy on the back, kind to the eyes.

Always Ahead of the Parade

Naturally such in outstanding feature was too good to go unnoticed by other radio makers . . . but none can duplicate the streamlined beauty of the curved front panel. This design is an exclusive Admiral patent. Admiral alone combines tilt-tuning convenience with smart, artistic cabinet styling.

But that's not all! Only Admiral for 1938 gives you "tilt-tuning" plus electric "Touch-O-Matic tuning" . . . twin features that make Admiral the outstanding "buy" of the year. You owe it to yourself to get the whole Admiral story now. Mail coupon below today!

**CONTINENTAL RADIO & TELEVISION
CORPORATION**
325 W. Huron St. Chicago, Illinois

25 MODELS TO CHOOSE FROM

FROM the sensational new Admiral "Duettes" with their dual utility . . . to smart table models . . . to flowing-lined Armchair radios . . . to splendid new "tilt-tuners" . . . you have radio at its best — radio for every kind of electric current . . . for city and country . . . radio built for satisfaction-giving performance . . . radio styled in the best of good taste. That's Admiral for 1938!

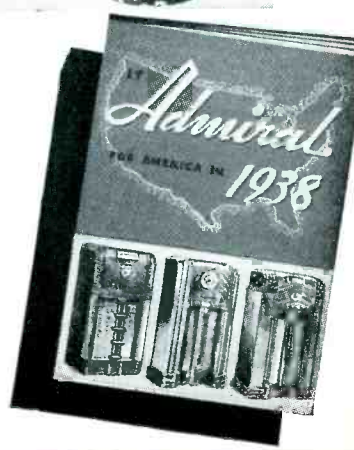
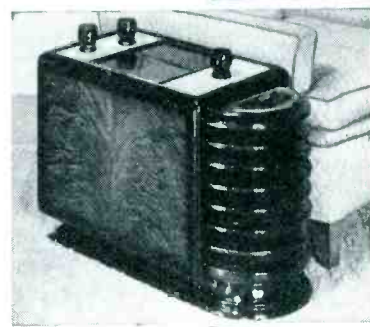

MAIL THIS COUPON FOR FREE CATALOG!

Just sign, tear out and mail to
Continental Radio & Television Corp.
325 W. Huron St., Chicago, Ill.

Name

Address

Zenith Ups Prices

List increase averages \$5 per receiver on new 138 line

CHICAGO—Effective August 2, E. A. Tracey, vice-president in charge of sales for Zenith Radio Corporation, raised list prices on a majority of models in this company's new 1938 line. The increase, amounting on the average to about \$5 per receiver, was necessary, he stated, to compensate for the increased cost of all materials.

In commenting on the list increase Tracey stated: "When we introduced our new 1938 line of receivers at the Zenith Distributor's Convention held in Chicago late in May we could have listed the entire line at five dollars higher and still have provided competitive values far above the ordinary. But because of quantity purchases of material we had made at favorable prices, we decided that we could give Zenith dealers a big advantage if we were to enable them to pass these extraordinary values on to the public for as long a time as it was possible for us to make them available. Consultation with many dealers and distributors indicates that the new price listing eliminates the antenna controversy for both dealer and consumer."

Emerson-N. J. Moves

NEWARK—Emerson-New Jersey, Inc., of which Sam Gross is president, has moved from 24 Belmont Ave. to larger quarters at 122 Branford Place. Business already booked, says president Sam Gross, crowded the old distribution headquarters to the bursting point.



TWO, NEARER TOP—Carl E. Peters (left) steps up as The B-L Electric Mfg. Co's. new secretary. Irvin W. Veigel becomes this St. Louis rectifier-condenser maker's comptroller and treasurer

Name Change For Andrea

Manufacturer active in export field for past 3 years also secures RCA license

WOODSIDE, N. Y.—F. A. D. Andrea, Inc., has changed its corporate title to Andrea Radio Corporation.

Frank A. D. Andrea, president, one of the pioneers in the radio set manufacturing business, announces that he has, also, completed direct negotiations with the Radio Corporation of America for the manufacture of radio receivers under license covering all this company's patents



WESTERN KADETTE—C. J. Pilliod, International Radio's western sales manager, snapped on a visit to the Ann Arbor plant



Radio Retailing printed the news that-

- ... half the manufacturers now made a.c. sets
- ... one favored type 199 tubes in series
- ... Columbia had just announced a new broadcast chain
- ... 19 set-makers had so far been licensed
- ... A-K would appeal the Alexanderson patent case
- ... Columbia Phonograph had entered the radio field
- ... overproduction was likely in the coming season
- ... the replacement market seemed to be here
- ... conventions should not be for entertainment
- ... RMA was shortly to feature a National Radio Day

and those controlled by it.

Andrea will shortly announce a complete line of a.c., a.c.-d.c., battery and auto radios and radio phonograph combinations for domestic distribution. An aggressive merchandising and distribution program is now in preparation.

R. M. "Rube" Coburn, formerly general sales manager for National Union Radio Corp., goes with Andrea as general sales manager.

Robin Joins Vocagraph

CHICAGO—John Meck, president of the Electronic Design Corporation, maker of Vocagraph Sound Systems, announces that Harry Robin, until recently with a leading amplifier maker and prior to that general manager of a prominent parts jobbing house, has been appointed central district salesmanager for the Vocagraph division.

Robin is at present touring the middle western states contacting jobbers, amplifier specialists. He will headquarter at the Chicago factory.

GET READY NOW for the Biggest Selling Season in Farm Radio History



Increase Your Sales and Profits with Willard's New Line of Radio Batteries

• Millions of listeners all over the country depend on battery power for their market reports, news of the day, entertainment and all the good things radio brings them. Hundreds of battery receiver owners right around you are going to be in the market for new batteries mighty soon.

In your community they are depending on you to select the kind of batteries that will assure them of good reception at a reasonable price.

With 35 years' experience in building batteries, Willard has built the kind of performance into this line of 2 and 6 volt radio batteries that will bring you *more sales, more profit, and more friends.*

• • •

Find out how you can increase your profits for the 1937 selling season. Tear off the lower right hand corner of this advertisement, write your name and address on the coupon and mail it today.

Especially designed for radio, these new Willards are equipped with noiseless, tight-fitting connections and convenient bail-type handles. These batteries last longer and perform better—yet they cost no more.

Willard has a special proposition for radio dealers that makes it easy to add these new batteries to your stock and a fast moving merchandising plan that speeds up sales.

WILLARD STORAGE BATTERY COMPANY
 Cleveland, Ohio • Los Angeles, California

Please send me at once complete details on the new Willard Radio Battery Franchise.

Name _____

Address _____

City and State _____

Willard

RADIO BATTERIES

cost less to own

You buy

PLUS FEATURES

When you buy OPERADIO INTERCOMMUNICATING SYSTEMS



Model 145-10 Intercommunicating System in either Wood or Steel cabinet. List Price from \$41 to \$47 per station.



Model 135 Intercommunicating System in either Wood or Steel cabinet. List Price \$57.50 per pair.

GIVING you everything that you can buy in other I. C. Systems, OPERADIO Intercommunicating Systems give you PLUS features that you can obtain nowhere else. The famous conference hook up—which permits two to four people to talk with each other and hear each individual conversation just as though they were together in one room is but one of the Operadio PLUS features. Technically perfect . . . guaranteed to give longer and better performance, they also have a beauty of design and finish that breaks down all sales resistance the minute the buyer sees them. Models with ear phones available for confidential conversation.

Take on the Operadio line, and you take on the 1937 Profit line. Buy no others until you see it. Address Dept. R5T for complete descriptions and illustrations.

The Most COMPLETE Line of P. A. EQUIPMENT, P. A. SPEAKERS AND RADIO REPLACEMENT SPEAKERS THE MARKET AFFORDS. EASY TIME PAYMENT PLAN. Send for our new Catalog. Address Dept. R5T.

THE PRICED RIGHT LINE . . . THE LIBERAL DISCOUNT LINE . . . THE 1937 PROFIT LINE!

*"To established importers abroad: The MOST VALUABLE FRANCHISE in the PUBLIC ADDRESS SYSTEMS field is still available for some countries. Write TODAY for details.
Foreign Division: 145 West 45th Street, New York City, N. Y.
Cable Address: Lopreh, New York*

★
OPERADIO
MANUFACTURING COMPANY
ST. CHARLES . . . ILLINOIS

FRONT MEN FOR FACTORIES

SOLAR—Leo C. McCarthy now represents this firm in the Chicago met area, for jobbing accounts. Leroy Eschner continues as senior rep for northern Illinois manufacturing accounts. Irvin Aaron of Milwaukee will tackle northern Illinois jobbers.

STROMBERG-CARLSON—Lee McCanne, radio sales manager announces three new radio distributors: Graybar Elec. Co., Indianapolis to cover Central Indiana; Hugh and Co., Spokane for western Montana, northern Idaho and eastern Washington; Graybar Elec. Co., Seattle for western Washington.

F. Douglas Spore, veteran Bath, N. Y. radioman, joins Graybar Electric, Syracuse, will specialize in Stromberg-Carlson equipment. Matthew J. Mendes has just been named by Gross Sales, Inc., as radio representative for this line in northern New Jersey, including Orange and Rockland counties, was last credit manager for the Newark branch of G. E. Supply of New Jersey.

SYLVANIA—Announces transfer of Howard J. Fairbanks, former Baltimore representative to Pittsburgh sales division; replaces B. J. Erskine now administrative department, Emporium.

TRANSDUCER—11 new representatives; J. A. McCaffry, Michigan; W. B. Weyrick, Ohio and Indiana; Morris F. Taylor, South Atlantic Seaboard; George W. Sipe, Mississippi, Louisiana, Kentucky, western Tennessee; Lee Maynard, middle west with headquarters in St. Louis; J. R. McCarty, metropolitan Chicago; Hal F. Corry, Texas, New Mexico and Oklahoma; Sam Egert, metropolitan New York; C. G. Van Loan, Minnesota, Wyoming, Montana, the Dakotas and Wisconsin; Dave Ormont, New England; Nathan Lazarus, New Jersey, Pennsylvania and New York.

TRIUMPH—For New York and Boston, Perry Saftler, 53 Park Place, New York City. Perry's just obtained this testing equipment line.

UTAH—M. K. Smith, well known southern parts jobber appointed sales representative for Alabama, Florida, Georgia, N. Carolina, S. Carolina and Tennessee; office at 440 W. Peachtree St., N. W., Atlanta, Georgia.

Lew Bonn of Minneapolis, Radio Accessories Company of Omaha and Burstein-Applebee of Kansas City now have the Utah line of transmitter kits for distribution. Maitland K. Smith, Utah's southern states representative, has moved from 440 Peachtree, Atlanta to 635 North Highland.

A SMASHING SUCCESS!



Sentinel with RAD-O-FONE

THE SPECTACULAR NEW DEVELOPMENT WITH REAL SALES PUNCH!

WHAM! Sentinel's 1938 Line has hit the radio market like a ton of bricks. All over the country, on farms, in cities, they're talking about and buying RAD-O-FONE, the most spectacular radio development since the invention of the vacuum tube. It's got more real sales punch than any feature you've ever had—an absolute knock-out—a feature that you can really demonstrate—that's tangible—something that you can talk, can show, can SELL!

It lifts Sentinel clear out of the "entertainment only" class—and makes it a valuable household and commercial utility.

But Sentinel has more than just RAD-O-FONE. This smashing new line is packed with features—features like the New Sentinel Automatic Tuning Dial, an instant hit! It's complete with 110 Volt A.C. models and 2, 6, and 32 volt Farm models. It's sensibly priced with leaders at \$19.99 and \$24.95, sensational values, and really outstanding de luxe 11-Tube models for as little as \$99.95.

Go to town with Sentinel this year. Get on the Band Wagon—mail the coupon for complete information today!

What is RAD-O-FONE?

Rad-O-Fone is a sensational, exclusive development that makes every Sentinel a "DOUBLE PURPOSE" Radio. It consists of an extension speaker, that duplicates the performance of the Sentinel radio exactly, and, in addition, can be used as a two station communication system! Think of it! The equivalent of two radios, plus a private telephone system, all for a price your customers would pay for an ordinary radio alone. It's the biggest selling feature of the decade!

Other Sentinel Features!

- ★ Automatic Tuning
- ★ 2-Volt, 6-Volt, 32-Volt Farm Models
- ★ Sensible prices from \$19.99 to \$99.95
- ★ Finer Performance than ever before
- ★ New Battery Economy, No "C" Batteries required
- ★ 6-Volt—110 Volt Alt. Current Combination Model
- ★ Sensational Merchandising Campaign
- ★ Nationally advertised

MAIL THIS COUPON NOW!

SENTINEL RADIO CORPORATION

2222 Diversey Pkwy., Dept. RRA, Chicago, Ill.

Please send me complete information on the 1938 Sentinel Line.

Name

Address



Sentinel

THE DOUBLE PURPOSE RADIO

— to Help Radio Dealers Make a Decent Net Profit!

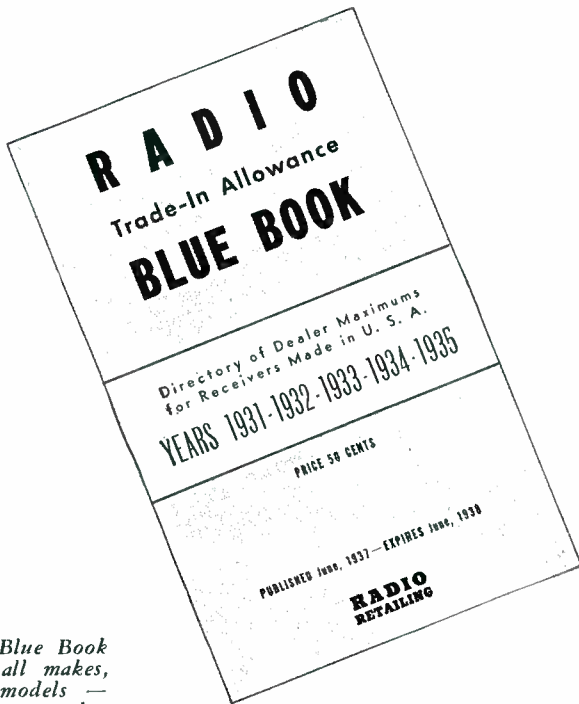

The Blue Book lists all makes, and models — cabinets — tubes — etc. for years 1931 to 1935.

Single Copy Price
50 Cents

quantity prices on request.

the first authentic, comprehensive directory of dealer maximum allowances for receivers made in this country by practically all manufacturers from 1931 to 1935 inclusive.

So widespread was the call for this data that now RADIO RETAILING HAS REPRINTED THIS INFORMATION in special, convenient, useable book form. Every radio dealer should have a copy at his elbow — every salesman in his pocket!

Order *your copy* of the "Radio Trade-in Allowance Blue Book" today! For convenience, attach the coupon to your letterhead and send it with money order or check.

RADIO RETAILING

330 W. 42nd St.

New York City

PAGE 46

That's the prime purpose
of RADIO RETAILING'S

RADIO TRADE-IN ALLOWANCE BLUE BOOK

Every radio dealer is faced with the problem of the trade-in allowance . . . of a fair appraisal and evaluation of the old receivers that so often enter into (and so often make or break) the sale of a new set. Every dealer knows how allowances tend to rob him of his fair net profit.

To help dealers so perplexed to make the net profit that is their due, RADIO RETAILING, in its June issue, published

RADIO RETAILING

330 W. 42nd St., New York City

Send me copies of The Radio Trade-In Allowance Blue Book for which I enclose \$

in { Money Order —
Check —
Stamps —

Name

Firm

Street

City State

RADIO RETAILING, AUGUST, 1937

PREVIEW of NEW PRODUCTS

HANDY-PHONE

General Electric Co.
Bridgeport, Conn.

INTER-OFFICE SYSTEM
—Consists of one FM-41 master station and from 1 to 4 FS-5 remote speaker-phone stations; master station may hold individual 2-way conversation with remote station or speak to all 4 stations simultaneously



STEWART WARNER

Stewart Warner Corp.
1826 Diversey Parkway, Chicago, Ill.

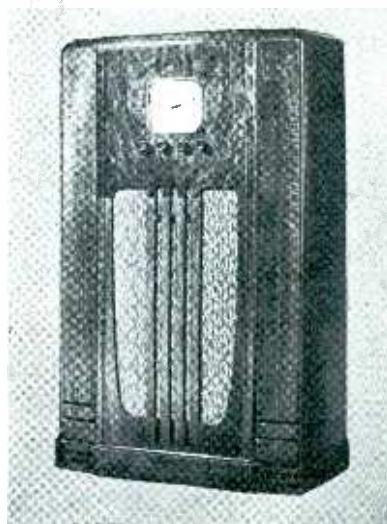

BATTERY MODEL 1915
—5 tube, 6 volt superhet; standard and police bands; 5 in. Magic Dial; precision station selector; avc; outlet for 6 v. lamp; powered by 6 v. storage battery; 8 in. p.m. dynamic speaker; same chassis also available in table model

BATTERY MODEL 1921
—6-tube, 6 volt superhet; three-band tuning; 5½ in. Magic Dial; precision station selector; avc; outlet for 6 v. lamp; 6 in. p.m. dynamic speaker; moderne cabinet with louver type speaker grille at end of cabinet



SOUND PRODUCTS

Sound Products
704 N. Curson Ave., Hollywood, Calif.

HOLLYWOOD RECORD PLAYER — Will play and automatically change eight 10 in. records or seven 12 in. records; comes in a modern cabinet of armchair height; all controls are on top—the lid disappears



MALLORY

P. R. Mallory & Co., Inc.
Indianapolis, Ind.



REPLACEMENT CONDENSERS — Mallory's condenser line has been expanded to meet new requirements by the addition of 21 numbers; several special universal condensers have also been designed for use on receivers requiring parts of unusual mechanical construction

SOUND SYSTEMS

Sound Systems, Inc.
1311 Terminal Tower, Cleveland, Ohio



INTERCOM-MUNICATOR KIT — The previously announced intercommunicator inter-office unit now available in kit form; all parts fully assembled and each kit includes wiring diagrams; \$9.94; one amplifier may be used as a power unit in any of the 6 different types of installation

OPERADIO

Operadio Mfg. Co.
St. Charles, Ill.

117 PORTABLE UNIT —14-26 watts; uses beam power tubes; electronically mixes two microphones; provision for mixing 2 mikes and 1 phonograph; Velotron mike mounted on banquet stand; two 10 in. electrodynamic speakers; tone control



WEBSTER ELECTRIC CO.

Webster Electric Co.
Racine, Wis.

MOBILE SYSTEM — Operates on 6 dc or 110 ac; equipped with 4 speaker receptacles with changeover switch to match speaker load to amplifier; input for one mike and phonograph which can be mixed; easy access to motor switch, speed control switch and needle cup; streamlined design



PORTABLE SYSTEMS— 5 and 10 watt amplifiers with two inputs, volume and tone controls; dial plates have specially designed and large size numerals; supplied as follows: complete system including microphone, carrying case and tubes or chassis with or without tubes

BENDIX

Bendix Home Appliances, Inc.
528 Fisher Building, Detroit, Mich.

LAUNDRY MACHINE

—Marks entry of Bendix name in home appliance field; does entire washing automatically; handles 9 lb. wash at one time; automatically soaks and agitates clothes, washes them, gives them 3 fresh water rinses and after last rinse spins clothes damp dry; machine then shuts off



TECH

Tech Laboratories
703 Newark Ave., Jersey City, N. J.

VERTICAL MIXER — Contacts are arranged in an arc, rather than in a circle, and so placed that the motion is vertical; provides easier operation, better indication of volume setting of each unit; narrow construction permits as many as 7 mixers in one row on a standard 19 in. rack; two models, \$14 and \$16

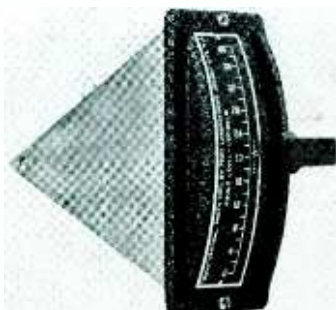

VELOTRON

Bruno Laboratories, Inc.
30 W. 15th St., New York, N. Y.

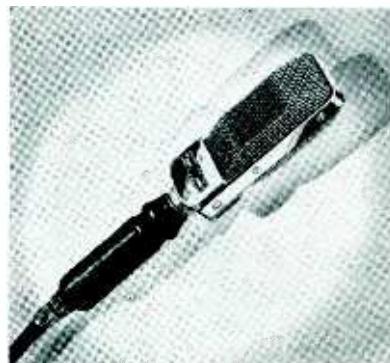

MODEL HA MIKE — Hand style; strictly a close talking model; will not pick up extraneous noises; output of -50 db.; impedance to grid; frequency response is adjustable (30-14000 c.p.s.) and requires a polarizing voltage of 150-350 v.; weighs only 13 oz.; \$23, less cable

SUPREME

Supreme Instruments Corp.
Greenwood, Mississippi



541 SET TESTER—Designed around Supreme's new flush-panel type meter which is encased in brown mottled Bakelite and has large, easily read scales and a rugged 1 m.a. hitorque movement which is heavily damped; instrument measures only 7 1/4 x 10 1/4 x 4 1/2 in. and weighs 9 lb.; \$26.95

ROTO

Roto Calculating Devices Co.
354 Roger Williams Ave., Highland Park, Ill.

WORLD TIME CHART

— Printed on heavy cardboard with lacquer finish for durability and permanence; shortwave addicts can quickly tell time in any part of the world; attractively done in color; suggested retail price 25 cents

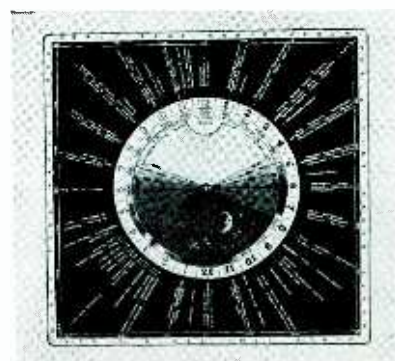

HOW LITTLE FACTS BECOME

big ones

THE *1st* FACT

is that consistent advertising in RADIO RETAILING will more effectively help to strengthen your distribution and reduce your sales costs today than ever before.

WHY? *The answer leads to*

FACT 2 Because the number of paid subscribers (please note that PAID) to RADIO RETAILING has increased from 16,159 as of June 1936 to 19,556 as of June 1937. (Total monthly distribution now 22,000). This means that the live audience of your potential and actual dealer and service customers is greater by 21% than ever before.

Fact 2 points right to

FACT 3 which is that RADIO RETAILING is the *only* radio dealer trade publication at the present time whose circulation is *audited* by the Audit Bureau of Circulation. And this fact is *your protection—your assurance that you get the advertising coverage you pay for!*

*But this isn't all--
there's another
fact to consider*

FACT 4

Your advertising in RADIO RETAILING has as a background a greater number of useful (to the reader) editorial pages, per issue, than any other radio journal in the field. What this means is indicated by the further fact that the response of these readers to the June issue of RADIO RETAILING was contained in approximately 500 letters, and over 900 post-cards commenting on the various features of this book and including over 36,000 requests for information on products advertised and literature described.

P. S. These are *facts*. And facts are stubborn things when supported by evidence. They mean everything to the advertiser who wants his advertising dollars to go a long way — and produce returns all the way.

It's the *right time* to tell your sales story to the *right people* — and RADIO RETAILING is the *right medium* to use.

RADIO RETAILING

A McGraw-Hill
Publication
330 W. 42nd St.
New York, N. Y.

CROSLLEY

Crosley Radio Corp.
Cincinnati, Ohio

SAVAMAID H-710 WASHER — 18-gallon tub with aluminum agitator; Lovell wringer with end lever safety release; finished with three coats of white porcelain enamel, inside and out; mechanism is sealed



MODERN

Modern Engineering Co.
2001 Champlain St., Toledo, Ohio

TRUMPET UNIT — Permanent magnet type; combines extremely high watt for watt efficiency with maximum input wattage capacity, it is claimed; full line of all-aluminum trumpets (41, 51, 63 and 72 in. overall lengths) also made



J.F.D.

J.F.D. Manufacturing Co.
4111 Ft. Hamilton Parkway, Brooklyn, N. Y.



REMOTE-O-CABLE RE-PLACER—Removes old fittings; swedges shafting to prevent unraveling; cuts shafting to exact length; replaces old fittings on new shafting; length, 16 in.; width, 5 1/2 in.; \$47.50

HICKOK

Hickok Electrical Instrument Co.
Cleveland, Ohio



VOLT - OHM - MILLIAMETER—Model 4955-S; for general circuit testing on both ac and dc circuits; new square meter, 4 in. scale length; special low ohms range tests radio speaker coils, r.f. and i.f. coils; has high sensitivity 350 microampere movement; rotary switch eliminates jacks

BELL SOUND

Bell Sound Systems, Inc.
Columbus, Ohio

MODEL 412 P.A. SYSTEM—Designed for any type of installation—permanent or temporary; 12 watts; crystal microphone; high gain amplifier; 7 octal series tubes; dual input channels; heavy duty speakers; Keratol covered carrying case; 16x19x13 1/2 in.; weight, 50 lb.



KREISLER

Kreisler Communications, Inc.
250 W. 57th St., New York, N. Y.

INTER-COMMUNICATORS — Adaptable to all requirements—wired up to 18 station and wireless for two-point two-way communication; feature of the All Master system is that two-way conversation may be carried on without use of a talk-listen switch; any model in color at slight extra cost; systems vary in price from \$34.75 to \$50



UNIVERSAL

Universal Microphone Co.
Inglewood, Calif.

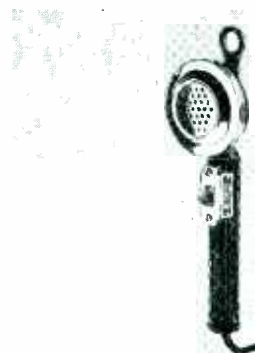

CRYSTAL HANDI-MIKE — First in a new series of crystal microphones; other standard types to follow; small and compact it comes with switch and 10 ft. of shielded rubber cord; crystals of the Brush Development Co. will be incorporated in this new line

SONORA

Sonora Electric Phonograph Co., Inc.
160 Varick St., New York, N. Y.

PHANTOM PLAYER—

Records are placed in a horizontal slot, the electric hand automatically sends the record to the turn table and places the pickup on the record; record is automatically ejected when finished; record may also be ejected by pressing a lever; self-contained amplifier; walnut chairside cabinet.

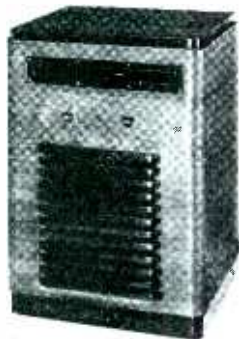

UNITED TRANSFORMER

United Transformer Corp.
72 Spring St., New York, N. Y.

BA-189 FILTER—For commercial aircraft service; consists of a combination band pass and band rejection unit which permits simultaneous voice and beam reception on aircraft receivers; weighs only 3 1/4 lb. as compared to original units which weighed approximately 30 lb.



RADIART

Radiart Corp.
133rd St. at Shaw, Cleveland, Ohio



4100 VIBRATOR CHECKER—Checks all types of auto or 6 v. household vibrators — half wave, full wave, synchronous, non - synchronous, shunt, series or driving point, regardless of lead or prong arrangement; universal adapter provided; only 2 switches and a meter compensator need be set for making all tests \$19.50

CLARION

Transformer Corp. of America
69 Wooster St., New York, N. Y.



OSCILLOGRAPH KIT

—Uses new 1 in. 913 cathode ray tube; "saw tooth" sweep circuit built in as well as wide range vertical amplifier with provision for cutting amplifier in or out; linear sweep for 5 position switch for selection of sweep frequencies

SPELL-O-LIGHT

Besbee Products Corp.
Trenton, N. J.

SPELL-O-LIGHT CONTACTS—Automatic device to provide inexpensive animation for window displays; first unit of a given string connects with outlet, whereupon the first bulb flashes on, followed by the second, third and so on; when all bulbs are on for a few moments, the string extinguishes and the cycle begins again

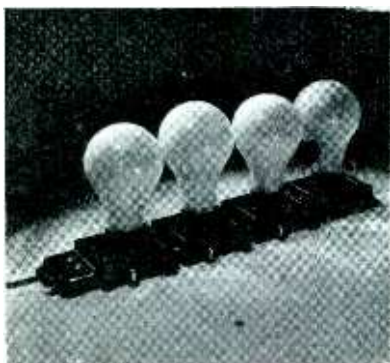

GRIP POINT

Stromberg Motoscope Corp.
2701 Belmont Ave., Chicago, Ill.

GRIP POINT SCREW DRIVER—Designed to anchor screws in hard-to-get-at places; has grip point which, when released by lever, ejects and revolves, gripping the screw-slot firmly; thus, screw may be "set" and screwdriver operated with one hand



WEBBER

Earl Webber
1217 W. Washington Blvd., Chicago



TEST BENCH—Supplies complete test for any service problem. Signal generator, analyzer, vibrator analyzer, tube tester, speaker tester are built in. Convenient outlet plugs. Sturdy construction, mounted on casters. Dual lighting

LAFAYETTE

Wholesale Radio Service Co., Inc.
100 Sixth Ave., New York, N. Y.

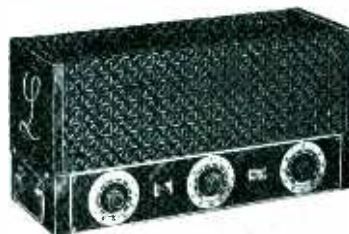

131-A AMPLIFIER — Has glowing red neon control dials which can be seen and set in darkened locations; metal tubes throughout, except rectifier; two high gain and two low gain channels; 20 watts

THE CONVERTER THAT OBSOLETED 32V SETS

OPERATES ANY 110 VOLT A.C. RADIO FROM 32 VOLT POWER PLANTS



With an *Electronic Converter* rural radio fans can select any make or model 110 Volt A.C. radio and get perfect operation from their farm lighting plant. Eliminates need for limited choice 32 volt sets having low trade-in value and easily obsoleted by new AC power lines. Get the facts today and start cashing in now on the marvelous money-making opportunities afforded by opening new rural markets for A.C. sets.

The Electronic Model 10 G converts 32 Volts D.C. to 110 A.C.

LEADING MANUFACTURERS RECOMMEND AND USE ELECTRONIC CONVERTERS

Arvin
Canadian Marconi
Clough-Bronle
Eastman Kodak
Fairbanks-Morse
General Electric
Mohawk Radio, Ltd.

Northern Electric
Rogers Majestic
Simplex
Sparton
Sparton of Canada
Stewart Warner-Alemite
of Canada

Stromberg-Carlson Tel. Mfg. Co.
Stromberg-Carlson Tel. Mfg. Co. of Canada, Ltd.
Universal Battery Co.
Zenith Radio Corp.

ELECTRONIC LABORATORIES, INC.

Dept. RR837

Indianapolis, Ind.

McGraw-Hill

DIRECT MAIL LISTS



As publishers of Radio Retailing for twelve years, McGraw-Hill is uniquely equipped to offer complete, authoritative Direct Mail coverage of the Radio Trade. Extreme accuracy (guaranteed 98%) is maintained on a daily corrected basis and the widest possible selections are available. Send for folder entitled "Hundreds of Thousands of Reasons Why" which describes how McGraw-Hill lists are built and maintained.

What Selection Do You Want to Reach?

- Radio Wholesalers
- Radio Dealers
 - Larger Dealers
 - Smaller Dealers
- Occupational Groups
 - Automotive Stores
 - Central Station Stores
 - Hardware Stores
 - Etc.
- Radio Service Dealers and Service Men
- Geographical Selections
- Population Groups

Write for folder "Radio Trade Outlets" giving details on selections, state counts, prices, etc. . . . or ask any representative.



DIRECT MAIL DIVISION . . .
McGraw-Hill Publishing Co.
330 W. 42nd STREET NEW YORK, N. Y.

JUMBO

Jumbo Battery Manufacturers
Ellsworth, Iowa

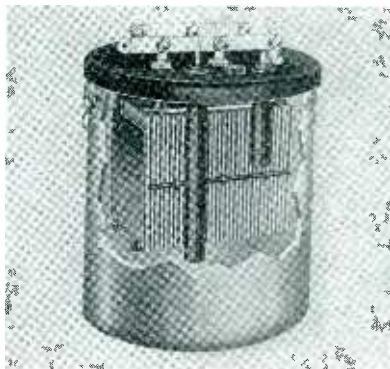

STORAGE BATTERY — With its capacity of 881 amp. hr., this battery is especially designed for use with wind driven generators to have large load carrying ability during periods of low wind; each cell unit has a 2 v. rating and a float for indicating water level

ONAN

D. W. Onan & Sons
43 Royalston Ave., Minneapolis, Minn.

GENERATING PLANTS

—Complete line of water-cooled ac and dc models; 500, 1000, 2000 and 3000 watt capacity and particularly designed for marine installations; can be supplied radiator-cooled; manual cranking or self-starting with remote control

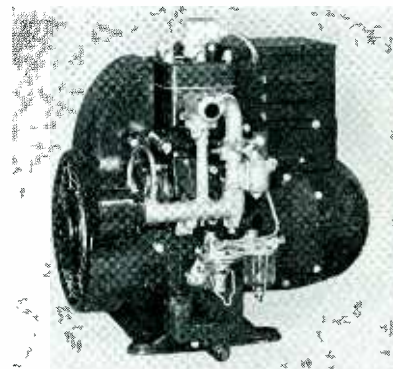

UNITED SOUND ENG.

United Sound Engineering Co.
St. Paul, Minn.



60-C AMPLIFIER — Compact, high powered unit; where reproduction of music is all-important, it can be operated at a low level, leaving the reserve power to handle the peaks without distortion

CLARION

Transformer Corp. of America
69 Wooster St., New York, N. Y.

SOUND SYSTEM — High-gain 20-30 watt amplifier; power packs for 6 v. and 110 ac operation built in; built-in single speed phonograph motor and crystal pickup; space in cover for carrying records; housed in modern metal container with removable cover



MISSION BELL

Mission Bell Radio Mfg. Co., Inc.
831 Venice Blvd., Los Angeles, Cal.

ARTISTS MODEL 386C
—brings the tuning dials to the chair side; cabinet contains convenient magazine and smoking compartments; speaker is provided with a large baffle set in specially constructed air chambers.

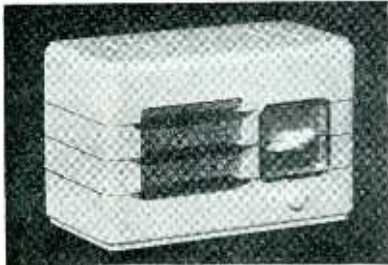

TEMPO MODEL 387B—
For bedroom, kitchen or den; golden plated speaker shutters and dial escutcheons; finished in glistening ivory.

CONTINENTAL ELECTRIC

Continental Electric Co.
Geneva, Ill.

MERCURY VAPOR RECTIFIER TUBE—Type 2-RA-15; designed for low voltage applications such as projector arcs, arc welders and similar equipment; filament voltage, 2.5 v.; filament current, 16 amp.; dc output (average) 15 amp., crest, 45 amp.

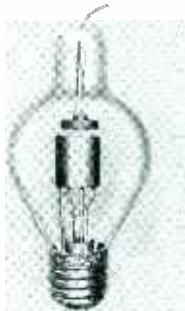

HAMMARLUND

Hammarlund Mfg. Co., Inc.
424 W. 33rd St., New York, N. Y.



SUPER-PRO CHASSIS
—Standard and crystals models for three tuning ranges, 7 1/2-240, 15-560, 15-2000 meters; 8 metal and 8 glass tubes; high fidelity audio; two stages of r.f. on all bands.

RADIO RETAILING, AUGUST, 1937



NOT in years has there been such a heavy demand for wire in connection with the Serviceman's business. You have noticed it—we have noticed it.

With Public Address going like a prairie blaze and Radio a seething hotbed of activity which promises to be sustained, you will be needing **GOOD WIRE**.

CORWICO Wires are scientifically produced to do their job 100%. Antenna Systems, P-A Cables, Hook-up Wires—"made by engineers for engineers." Use **CORWICO** on your next contract.



NOISE-MASTER
ALL-WAVE ANTENNA

Eliminates "Man-Made" Static on Broadcast as well as Short Waves

LICENSED by Amy, Aceves & King, engineered with traditional **CORWICO** care, this masterly aerial system fits every set and every location. Filters out nuisance noises caused by electrical devices. Improves reception generally—widely endorsed by Service men.

No. 14 (illustrated above) **\$6.75 list**

FOR broadcast and shortwave frequencies; designed to eliminate "man-made" static and afford better reception. Two to 6 sets can be operated at the same time with an additional lower transformer for each added unit. Other "Noise-Master" units available.

WRITE FOR INFORMATION.

CORWICO Wire Catalog available to Service men.
Distribution is exclusively through Jobbers.

CORNISH WIRE CO., Inc.

30 Church Street  New York, N. Y.



COMPARE
Majestic
with
THE FIELD!

COMPARE

... THE EXCLUSIVE MAJESTIC
FACTORY-TO-DEALER PLAN ...

Merchandising advantages that guarantee mark-ups, protect profits and safeguard territories!

... THE BEAUTY OF THE MAR-
VELOUS NEW COMPLETE 1938
LINE OF CONSOLE, CHAIRSIDE
AND TABLE MODELS!

... MAJESTIC ADVANCED TECH-
NICAL FEATURES ...

A. B. C. (Automatic Base Compensation)
A. V. E. (Automatic Volume Expansion)
A. F. C. (Automatic Frequency Control)
Telematic Automatic Tuning • Complete range of models with exclusive MAJESTIC Electric Automatic Tuning.

... THE PRICE RANGE THAT
MEETS EVERY MERCHANDIS-
ING REQUIREMENT!

*Make These Comparisons
NOW!*

**WRITE TODAY FOR COMPLETE
INFORMATION REGARDING AN
EXCLUSIVE DEALER FRANCHISE
FOR YOUR TERRITORY!**

**MAJESTIC RADIO &
TELEVISION CORP.**

2600 W. 50TH ST. • CHICAGO, ILL., U. S. A.
Cable Address: "MAJESTICO—Chicago"

TINY TIM

Continental Motors Corp.
Detroit, Mich.



BATTERY CHARGERS

—Tiny Tim, Jr., is a 150 watt, 6 v. model utilizing controlled voltage, has push button self-starter, \$45; 60, 240 watt 6 v. model with automatic shut-off is \$57; 120, 300 watt, 12 v. model is \$60; 320, 300 watt, 32 v. model is \$70; for an inexpensive 32 v. plant there is 110 AH battery for use in combination with 320, \$45

RADIART

Radiart Corporation
133rd St. at Shaw, Cleveland, Ohio

**TILT HINGE AUTO
AERIAL** — Adjusts to angle of windshield; extension type; rustproof stainless steel and brass, nickel and chrome plated; matched teardrop tip and modernistic insulator made of extra strength plastic in translucent red; \$2.75; in whip type, \$3.50

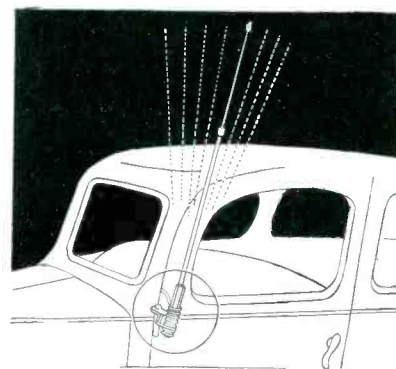

CAL-FON

Universal Microphone Co.
Inglewood, Calif.

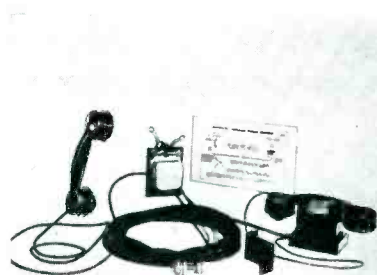

TRAILER PHONE — Desk or wall set for trailer and single handset for automobile cab with buzzer to mount on car dash for signalling; unique spring holder keeps French phone in position on any kind of road; plug and socket connections make it possible to disconnect instrument when trailer is detached from automobile

WESTERN ELECTRIC

Western Electric Co.
195 Broadway, New York City

**PROGRAM SOUND
SYSTEM** — Attractive centralized system; built in high fidelity multi-range receiver with automatic volume control. All switches conveniently located on bright black panel; talk back system for announcing from any speaker back to control room



RADIO RETAILING, AUGUST, 1937

COOLREST

Crosley Radio Corp.
Cincinnati, Ohio

COOLREST—To overcome the objection some people had to being enclosed, this year's model has a transparent canopy made of Pliofilm; temperature of compartment is quickly lowered 10° and the humidity of the air reduced; requires no plumbing and is easily transported and mounted; \$150 fob Cincinnati



GENERAL ELECTRIC

General Electric Co.
Bridgeport, Conn.

RADIO OUTLET—Convenient and attractive outlet for noise-reducing or doublet antennas; affords means of separable attachment for ground, antenna (two wire); and power leads; lead-in wires are thereby eliminated and replaced by neat, short lengths of cord; metal divider to separate the low and high tension circuits

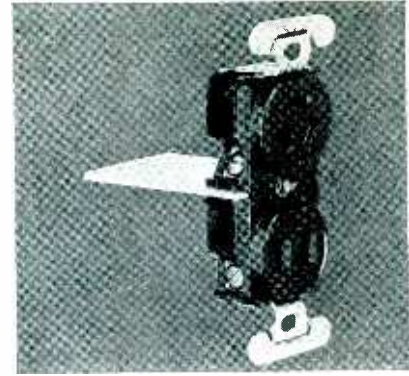

DRAKE

Drake Electric Works, Inc.
3656 Lincoln Ave., Chicago, Ill.



VARIABLE HEAT CONTROL — Regulates heat of soldering iron to suit individual requirements; keeps tip properly finned; for use with any iron not exceeding 150 watts input; 115 v. ac or dc only; \$3.50

FILMO

Bell & Howell Co.
1801 Larchmont Ave., Chicago, Ill.

STREAMLINE 8 MM. CAMERA—"Palm size and palm fitting"; single-frame device permits user to enjoy animation work; two speed ranges—8-16-24-32 and 16-32-48-64 frames per second; Taylor-Hobson 1 1/2 mm. F 2.5 lens, fully corrected for both black - and - white and natural color film



LOW DOWN ON HIGH LINES

(Continued from page 23)

thetic facts are presented which will serve as ammunition in what should be the biggest drive for rural radio sales in the history of the industry.

The data from which the map was prepared came directly from the Rural Electrification Administration and shows in solid areas the counties in which rural electrification has been completed. The shaded areas are those where high lines are in course of construction, while in the thinly dotted areas allotments of funds for high line construction have been made.

It is important to note that this map is based on reports right up to July 1, 1937 and includes all REA activities right up to the close of the government's fiscal year, June 30, 1937.

To further avoid the possibility that rural electrification rumors may continue to act as a cold blanket on hot sales, dealers should keep the following figures in mind.

There were in the United States 6,422,000 farm homes on January 1, 1935. When a count was taken two years later, on January 1 of this year 1937, only 898,000 of those farm

homes were getting high line service, or about one in every 7 homes. To that number the REA activities will add about 165,000 this year and private utility companies expect to provide another 160,000 rural customers with service so that at the end of 1937 about 1,223,000 farm homes will be so provided.

Then the REA has the announced goal of adding another 840,000 during the next 8 years, which program, if carried out, will bring the total of farms on high lines to 2,063,000. To this must be added the number that may receive such service through the extension of private utility companies.

However, as the latter is an uncertain quantity and even if we assume that nothing will occur either politically or economically, to interfere with the REA schedule, the whole flood of rural electrification activities about which we hear so much these days *will even in 1945 leave OVER FOUR MILLION farm homes WITHOUT HIGH LINE SERVICE.*

This means that even after 1945 there will be OVER FOUR MILLION homes that will have to use battery radio receivers, will use wind or gas chargers because they will have

no other way of getting radio reception excepting.

Use Knowledge To Sell

Thus the radio dealer who sells in rural areas must do two important things in order to make sure that he is equipped to make the best of his sales opportunities. These are:

1. He must keep himself fully informed on present activities and future prospects for rural electrification.

2. He must be constantly prepared to show his prospective rural buyers such authentic records and data as will prove convincingly just what the plans and prospects are in the territory where his customer is located.

To aid the radio dealer in doing this "Radio Retailing" will print in succeeding issues full details of construction allotments made by the government's REA as news of these is received, which together with the accompanying map will provide the evidence that the rural buyer wants before replacing old or buying new radio equipment.

Obviously the radio dealer who operates in rural areas has three broad avenues of attack for building bigger sales.

1. Where high line service is now

1938 RCA RECORD CHANGERS

give outstanding performance at moderate price

The upward swing of record sales gives you a golden opportunity to cash in on sales of new RCA Automatic Record Changers. Tell your customers about them. They mean *continuous* record music. Play a complete record album without interruption. Ideal for dance enthusiasts, too.

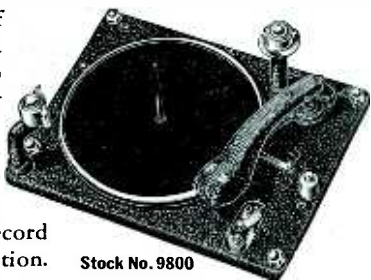

Stock No. 9800

eight 10" records—repeats last record. Plays and repeats one 12" record. 1400 ohms impedance.

List price, \$49.95.

Stock No. 9820...provides top needle loading with automatic position adjustment. New crystal pickup, with 40,000 ohms impedance. Changes either eight 10" records or seven 12" records. List price, \$99.50.

Stock No. 9800...small, fits most instruments formerly using manual boards. Changes

Stock No. 14818...40,000 ohm crystal pickup and arm—used on No. 9820 record changer—available separately. List price, \$14.95 including needle bracket.



Parts FOR PROFIT

RCA MANUFACTURING CO., INC. • CAMDEN, N. J.
A Service of the Radio Corporation of America

under construction he must follow through to every prospective meter on the line with the view of selling sets and accessories where there are none or selling plug-in sets and appliances where battery equipment was used previously.

2. Where high line service is in prospect for early construction or where REA allotments have been announced, an immediate study is desirable with the view of listing every customer that will be reached, calling on each prospect, taking a record of what radio and other equipment is now in use and making up a tentative list of the type of radio and other appliances that the farmer may be induced to buy, also where necessary preparing a financing plan that may help to put over the sale when the dealer makes his real sales drive well before the juice is turned on.

3. In territories where farm homes are far apart, where the power supply is far away, where potential customers on high lines are too few to make the project economically practical for either private utility or the government, there the full force of sales effort should be put behind battery sets, gas and wind chargers and allied equipment.

The important thing for every

dealer to remember is that farm buying is expected to reach a new peak during this year, in fact should be better than at any time since 1929 and rural areas therefore deserve to be made the subject of the most carefully planned and vigorously executed sales effort.

This applies to every rural area regardless of whether electrification is completed, under construction, being planned or out of the question.

• • •

FACTS ABOUT BATTERIES

(Continued from page 26)

are to be operated in addition to the radio.

Many battery-type receivers use 2-volt filament tubes. These, too, may be operated by means of storage batteries. They may also be operated from dry, non-rechargeable "A's" or from an "Air-Cell."

Dry "A's", available even in extremely remote localities, are initially low in cost, are not readily injured

by moderate overload. It is difficult to estimate their probable life, however, as the power that can be taken from them depends largely upon the rate at which it must be delivered. Used five hours a day, for example, such batteries will deliver fewer *total* hours of radio operation than when used two hours a day. The voltage output of the dry "A", furthermore, varies between approximately 3 volts when new and 1.8 when approaching the end of useful service. "Ballast" tubes included between battery and receiver level out the supply to some extent, keeping voltage at the tubes themselves reasonably close to the recommended 2 volts at which tube life and receiver performance is best.

The "Air-Cell" type non-rechargeable "A" battery, initially higher in price than dry "A's", delivers a definite number of radio operating hours, closely calculable in advance. Used to operate a radio drawing $\frac{1}{10}$ amperes, for example, at least 1500 hours may be expected, *regardless of how many hours the set is used per day*. On a $\frac{1}{2}$ -ampere drain receiver, 1200 hours or more is normal. On a $\frac{1}{10}$ -ampere set (unit not recommended with heavier drains than this and will definitely be impaired by overload)

ATTENTION

The United States Patent Office has issued **PATENT NO. 104968** to the Ward Products Corporation, covering the aerial models S.T.R. and T.A., also known as The "Stratosphere" and The "Tur-ette". Legal action will be taken against all infringers.

INSIST ON GENUINE
WARD AERIALS

PROMPT DELIVERIES



WARD PRODUCTS CORP.

WARD BUILDING

CLEVELAND, OHIO

DEALERS!

What is a fair trade-in allowance?

Read page 46 for the story of **RADIO RETAILING'S Radio Trade-In Allowance Blue Book**, the first authentic, comprehensive directory of dealer maximum allowances for receivers made in this country by practically all manufacturers from '31 to '35 inclusive.

This book can mean a fair allowance to the customer and at the same time a fair net profit to you.

SEE PAGE 46

6 Volt
**HY-TOWER CHARGER
INSTRUCTION MANUAL**
50c Per Copy

Parris-Dunn Corporation
Clarinda, Iowa, U.S.A.

CONSTANT RADIO
POWER FOR LESS THAN
1¢ A WEEK OPERATING
COST

PARRIS-DUNN CORPORATION

FREE·FREE 6-V CHARGER MANUAL

The most attractive and complete wind-electric technical and sales manual ever printed. Highly illustrated and containing, in detail, instructions for selling, installing and servicing wind chargers. Answers any question you might ask about:

- How and where to install.
- Correct wire sizes to use.
- How to wire for lights.
- Size, number and types of batteries for lights.
- Protection against lightning.
- How to get the farm market.
- Fair displays.
- Store displays.
- Profit without stock investment.
- Salesmen's car display.

Everything in wind charging fully explained in this most valuable manual prepared by the manufacturers of the famous Hy-Tower Charger—The Charger which, in the short space of 7 months, has received almost universal trade acceptance, being now custom-built for 39 of world's leading radio manufacturers and merchandisers for both export and domestic trade.

Get a copy today. IT'S FREE Yours for the asking.

USE COUPON BELOW

Parris Dunn Corporation, Clarinda, Iowa

Please send without obligation a copy of your valuable technical and sales manual.

Name

City State

Radio Handled

such a battery will deliver 1000 hours or more.

Another interesting feature is the fact that such units deliver essentially uniform output voltage throughout their entire length of life. Variation in voltage from the "new" to the "worn-out" condition is so slight that it may be ignored. Voltage is simply reduced by means of a fixed resistor to the value dictated by the current-drain of the set, the required 2 volts is delivered to tube filaments, and voltage stays that way until the battery reaches the scrap-point. No voltage adjustments, manual or automatic, are required within the life of the setup.

New Resistor Tube

About to break in the news is a new "resistor-tube" designed to permit the purchaser of a 2-volt receiver to quickly adapt it for use with 2-volt storage battery, dry "A" or "Air-Cell". Resembling a glass type 199 but having an octal base, pumped to a high vacuum and using no gas (generally included in ballast types), this tube incorporates within its envelope several "filaments" of definite resistances, these being connected to individual base-pins. Sockets designed

to receive the resistor tube will have three keyways, permitting the tube to be rotated to positions indicated on the base for the three battery types noted above. Thus this new tube becomes a combination step-type filament resistor and switch. Slight automatic ballast action is involved in certain positions.

"B" Battery Life

To our attention comes the report that complaints about short "B" battery life appear to be on the increase. Explanation offered by a leading manufacturer is that most complaints are probably from people using battery receivers for the first time and are due to the combination of heavy initial use during the "novelty" period and overstatement by dealers anxious to avoid set sales resistance.

The trade is cautioned against statements concerning the life to be expected of "B" batteries. Those in use today, while immeasurably improved in the past five years, are still dry or "primary" types whose useful life depends to a very marked degree not only upon the current demanded by each particular receiver but also, and to an even greater degree, upon the number of hours they are used

before permitted a "rest period". Without knowing precisely how many hours per day a radio is to be operated, and precisely how much the receiver draws, no one can estimate "B" battery life in advance.

Always Replace "C's"

Failure of the trade to insist upon replacing "C" batteries when "B" batteries are changed is also reported. A certain value of "C" voltage is essential for good reception with each "B" voltage value. Now, "B" batteries decline in voltage every minute after they leave the production line, faster when operating a set. So in order to keep "C" voltages declining in step with the "B's" (their position in the average circuit brings about little or no consumption of power) most makers of new battery sets include a "bleeder" resistor across the "C" batteries.

Where this is done the set engineer obviously calculates his "C" bleeder so that the bias battery will run down at about the same time as the "B's". Replacing "B's" and leaving the old "C's" in the set is therefore, certain to cause trouble, since low "C" battery voltage will decrease the life of any new "B's" installed.

SOUND ON A SHOESTRING

(Continued from page 28)

and 18 months on the balance." I bought a job I had had in mind for some time, one that is easily moved, can be used with its own power supply on the street or on an electric line indoors.

Since that time my P.A. business has grown by leaps and bounds. The best mobile job I have had so far was a five-day run advertising a rodeo put on by the local Lions Club. On these trips I had a driver and an attorney who served as an "inquiring reporter." After ballyhooing through the streets of a town we would stop at a curb and the attorney would interview people. To everyone who would talk over the mike he gave a pass to the rodeo. In five days we interviewed 300 people, most of whom got a real kick out of using a microphone even though their voices were not broadcast beyond the limits of one street.

Last season I again used my amplifier at the ball games and made out even better than originally. The ball

season alone netted me \$100.

Of course, it would be nice to have a sound truck and some day I hope that I can have the kind we read about and the kind that most radio-men think they have to have to get into amplifier work. Lack of a truck was no handicap on my first mobile jobs. I ballyhooed new models for Plymouth, Ford and Chevrolet. Naturally, these companies wanted me to use a car of their own make. So on the first few jobs I used brackets on the boxes containing the speakers, fastened these on the bumpers. Last winter when it was 30 below here in Iowa I spent some time indoors designing a removable top mounting for my speakers. This is not complicated, is easy to install and if one is careful does not leave any scratches on the customer's car. It also provides an ideal place for signs. (See *Service Section* for mechanical details.)

When the advertiser furnishes his own car it is not necessary to charge

for more than your time as he also supplies gas and oil. Elimination of car operating overhead permits bids to be much lower and the customer does not argue about high prices brought about by overhead it is difficult to explain. More deals go through on this basis, in my estimation, than if I had to charge for gas, oil and automobile wear and tear. Customers usually furnish their own signs, too.

Open to all

Any man who wants to get into P.A. work on a small scale can certainly do so. Just remember that sound work is something new and that 90 per cent of the places you rent equipment will know nothing about it before you start selling. This, in fact, is the principle obstacle. Unless you figure out a way sound can help them and then tell them about it you probably won't be very busy.

LOOK AT ALL THREE!

You'll see many advantages in the

SUPERCHARGER

- Operates in 4-mile wind
- 2 to 5 times more current
- 6-volts—25 amp. capacity
- 8-ft. propeller
- Works anywhere
- 10½-ft. galvanized angle iron tower, optional

Any way you look at it, SUPERCHARGER is the smart buy . . . and the best profit builder. Generates enough current to operate a few lights as well as radio in most areas. You can make more money with SUPERCHARGER without even stocking it! Learn how . . . write for full details!

32-volt models also available

BREEZ-ELECTRIC CORPORATION

Dept. 810, 440 N. Oakley Blvd.

Chicago, Ill.



Janette Rotary Converters



The original D.C. to A.C. converters with all wave filters developed exclusively for radio and sound apparatus.

CAPACITIES: 35 to 3250 watts.
6, 12, 32, 115 and 230 volts
D.C. to 110 or 220 volts, 1 phase,
60 cycle A.C.

Insist on a Janette
Ask For Bulletin No. 13-25

Janette Manufacturing Company

556-558 West Monroe Street Chicago, Ill. U. S. A.

BOSTON - NEW YORK - PHILADELPHIA - CLEVELAND - MILWAUKEE - LOS ANGELES
DETROIT - SEATTLE

TRIAD

Tripled-Checked Radio Tubes

IMPROVE YOUR RECEPTION

USED BY LEADING SET MANUFACTURERS
AND PREFERRED BY EXPERT SERVICEMEN

A Profitable Line to Handle—Write for Particulars

TRIAD MANUFACTURING CO., INC.

PAWTUCKET

RHODE ISLAND

The Quality Name in Radio Tubes

POWER TO SUIT THE PURSE

(Continued from page 25)

generators with which such private installations were initially equipped. They might even be used as auxiliaries when wind is blowing, permitting the user of gas driven systems to save money at such times.

Life of a good wind power plant is a moot question. Interesting is the fact that the first on record was built in 1894 for the Colonel Lewis of machine-gun fame, is still running down in New Jersey. Perfection of propellers came with the airplane, following the war, and today's wind-generators are ever so much more efficient than were early models.

Gas generators turning out 110 volts a.c. and therefore requiring no bank of batteries are now also available in extremely high output types. Manufacturers have learned much which has permitted design economies and consequently list price reductions as a result of experience with smaller models initially intended solely for radio battery charging. Thus the farmer may today buy gas generators turning out from 300 to 5000 watts of a.c. He can, when such generators are purchased, use precisely the same electrical appliances sold to his

brothers in the city, within the capacity of his plant.

The market for wind and gasoline driven generators, ranging all the way from the small units designed primarily for radio to the husky units practically equivalent to high-line service in output, is a particularly profitable one for the radio dealer. Low saturation is one of the reasons. The picture of rural America stacks up something like this: There are 6,422,000 farm homes in these United States. Of these, 897,873 are on power lines. Knocking these off, we have left 5,524,127 homes without high-line service. Of these—

270,000 have private systems
250,000 bought wind-chargers in 1936
25,000 bought gas chargers in 1936
250,000 are believed to own chargers purchased in previous years

795,000 farm homes are equipped with personal plants

This leaves 4,729,127 homes in rural areas without electricity's conveniences. Truly, this is a market worth shooting at!

Fifty users of heavy-duty wind electric plants were surveyed recently, reported sixty different types of electrical appliance in use. These included:

- | | |
|-------------------------|---------------------------|
| 45 Radios | 48 Washers |
| 40 Irons | 16 Refrigerators |
| 38 Water pumps | 27 Sweepers |
| 19 Separators | 3 Toasters |
| 5 Sewing machines | 10 Fans |
| 1 Oil burner | 1 Percolator |
| 7 Churns | 1 Massager |
| 1 Curling iron | 2 Ice cream freezers |
| 2 Food mixers | 2 Floor polishers |
| 7 Meat grinders | 1 Cider press |
| 1 Ironer | 1 Radiant heater |
| 1 Honey extractor | 1 Movie projector |
| 5 Christmas tree lights | 1 Hot plate |
| 2 Electric shavers | 1 Furnace fan |
| 2 Seed corn graders | 8 Utility motors |
| 13 Battery chargers | 10 Drills |
| 7 Saws | 12 Grain cleaners |
| 1 Feed grinder | 18 Grindstones |
| 3 Air compressors | 3 Soldering irons |
| 1 Forge blower | 2 Egg testers |
| 5 Electric fences | 1 Cement mixer |
| 1 Tire pump | 1 Henhouse Ther-movent |
| 1 Sickle grinder | 2 Milking machines |
| 1 Alarm system | 2 Lathes |
| 4 Corn shellers | 2 Feed elevators |
| 2 Paint sprays | 1 Cylinder honer |
| 1 Valve refacer | 1 Buffing motor |
| 1 Chicken water heater | 1 Radio phone transmitter |

The average home in this group owned 8 electrical appliances.

With the array of electricity creating devices perfected today, it is obvious that history is about to be made at night on the farm. And the radio dealer who uses the generating plant as an opening wedge will be in the best position to profit by it.

ANNOUNCING

RURALITE

A Complete New Line of Wind Driven Electrical Chargers offering A REAL DEAL FOR DEALERS

A new product manufactured in a new modern plant by experienced engineers who actually pioneered the wind charger industry. Sensational new-type 6, 12 and 32-volt plants are now available. And best of all, RURALITES will be offered to progressive dealers exclusively on a really profitable basis!

WRITE TODAY FOR FULL PARTICULARS

RURALITE ENGINEERING CO.
SIOUX CITY, IOWA



CROWE Auto Radio PANEL CONTROLS

for 1935-1936-1937 CARS

NEW DOUBLE UNIT DESIGN

LESS STOCK INVESTMENT—double-unit design—airplane or porthole dial types to match styling of any car—finer appearance—same controls for all cars—easy installation without sawing, filing or drilling—these are among the salient features of CROWE Auto-Radio Remote Controls.



Here's all you need: 1. Tuning Control Unit. 2. Volume Control Unit. 3. Panel Mounting Kit.



Quick assembly at bench—not in crowded driver's compartment.



Fits the instrument panel without mutilation. No sawing, filing or drilling.

Six gear ratios and other optional choices such as power switch, two-point or variable tone control, sensitivity switch, wave-band selector, are added features.

Ask for **Bulletin 202** which contains complete details.

PHILCO DEALERS!
Ask for Bulletin 201, especially for you!

CROWE NAME PLATE & MFG. CO.
1745 Grace Street
CHICAGO, ILLINOIS

COLLECT YOUR PROFITS *in* Advance

IT'S a rare occasion in any business when profits can be collected in advance . . . when you can "take yours" first, when you can sell before you buy.

But that is just what happens under the TUNG-SOL CONSIGNMENT PLAN . . . and more than 8,000 dealers are finding that the Tung-Sol franchise means more sales

as well as greater profit per sale.

Under this unique merchandising plan, you make your sales and take your profits before you pay one cent for your stock . . . You always have an *adequate* stock of these high-grade tubes...and you run no risk of loss through obsolescence or price changes.



TUNG-SOL

Tone-flow radio Tubes

TUNG-SOL LAMP WORKS, INC.

Dept. B Radio Tube Division

SALES OFFICES: Atlanta, Boston, Charlotte, Chicago, Dallas, Detroit, Kansas City, Los Angeles, New York
General Office, Newark, N. J.

The Tung-Sol franchise is still available to a limited number of dealers who can qualify. Write for the name of your nearest wholesaler.

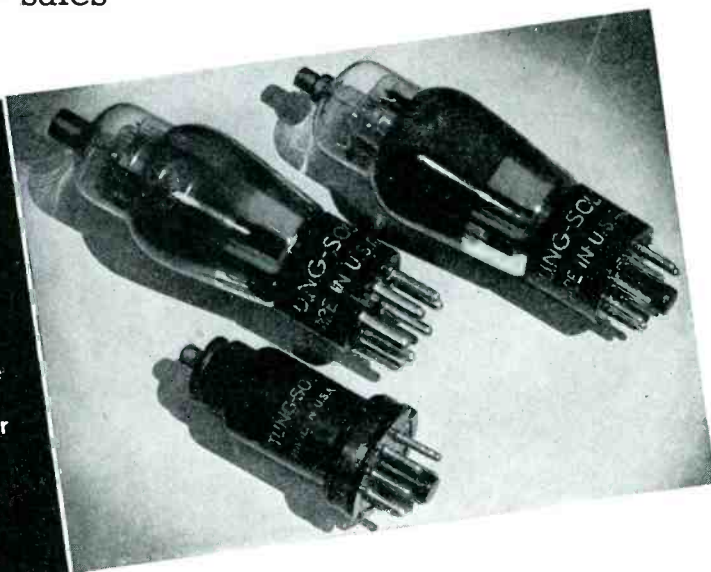

SERVICE

DESIGN • REPAIRS • INSTALLATION

CIRCUITS

Frequency Characteristics of Condensers

An interesting study of various types of condensers brings forth this chart by Cornell-Dubilier.

Condensers can be divided into four classes: air, mica, paper and electrolytic. Each type finds its most practical application to a distinct division of frequency. Starting at the low frequency end of the diagram we have first the electrolytic, and then the paper. The electrolytic becomes unsuitable for frequencies above 120 cycles. The paper condenser takes its place from this point up to 10,000 to 20,000 cycles, filling the gap throughout the audio range.

In the region above audio frequency, the mica condenser is the most desirable for handling power with low loss. It is practical to use mica tuned tank condenser for frequencies up to 4000 kc. Mica bypass condensers function well even up to 60 mc. (5 meters).

Air condensers make a good low-loss

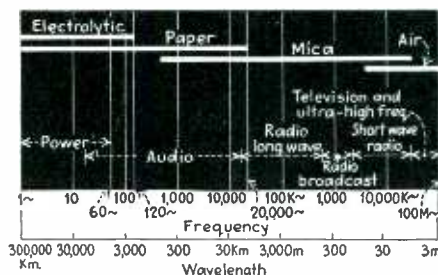

tank circuit below 100 meters. For frequencies lower than this its other uses are prohibited because of size.

Signal Admission Control

Sensitivity on the new Stromberg-Carlson receivers can be controlled in 5 steps. A capacity-switch network in conjunction with the wave-band switch shunts 4 values of capacity from the antenna network to ground.

As shown in the diagram, position 1 is for full sensitivity. In position 2 a single .002 condenser is added to the circuit. These capacities are added up

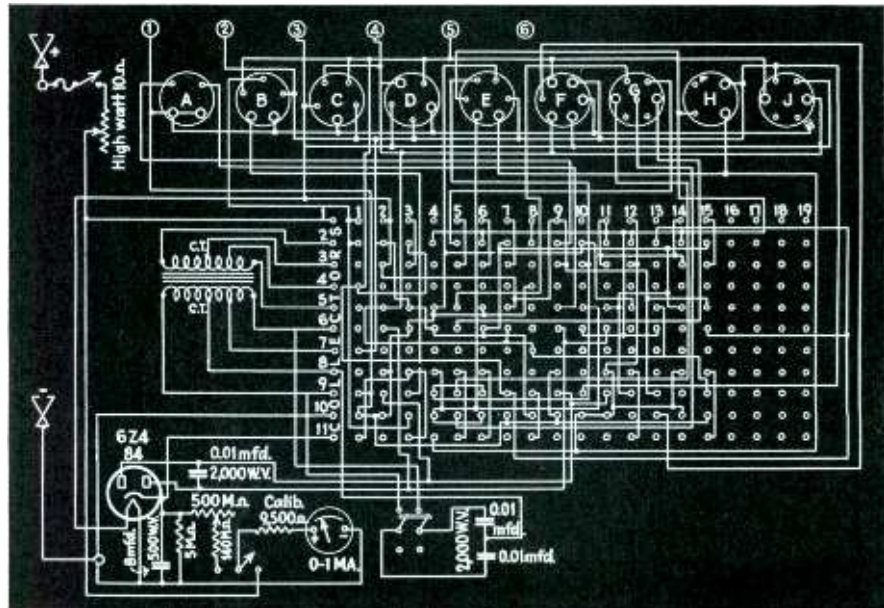

so that when position 5 is reached, a total of .008 mfd is in the circuit. This method of receiver sensitivity control is desirable since it prevents overload to any tubes in the circuit from strong local signals. The usual control in the cathode of the first rf stage does not protect that tube sufficiently.

Full sensitivity is available at all times on both short wave bands. The wave band switch automatically disconnects the sensitivity control circuit from the antenna when switched to other bands.

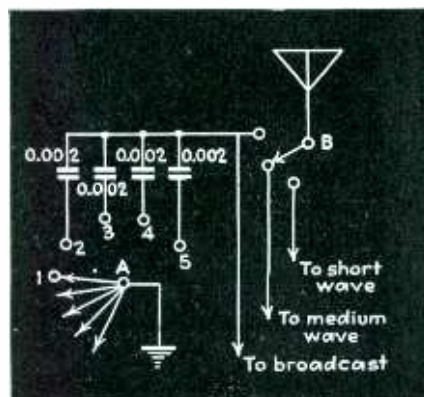

Vibrator Tester

A universal vibrator tester has been in demand for some time. The new Triplett, diagramed above, provides all the necessary tests and provisions for correct vibrator adjustment. The diagram appears complicated because of the multi-contact switch at right-center. This rotary switch connects the various sockets to the primary and secondary of the vibrator transformer.

An 84 rectifies the voltage delivered by the various vibrator types. In the cathode circuit of this tube is a calibrated 1 ma. meter. If the rectified voltage is low, the meter indicates a bad vibrator on the good-bad scale. High output vibrators swing the meter up to full scale. A switch in the meter circuit permits a voltage input reading also. This voltage may be adjusted by a rheostat in the positive A lead. Thus the over-all performance of the unit under test can be found.

A second switch places a buffer condenser in the output circuit of the vibrator transformer. It may be cut in or out at will.

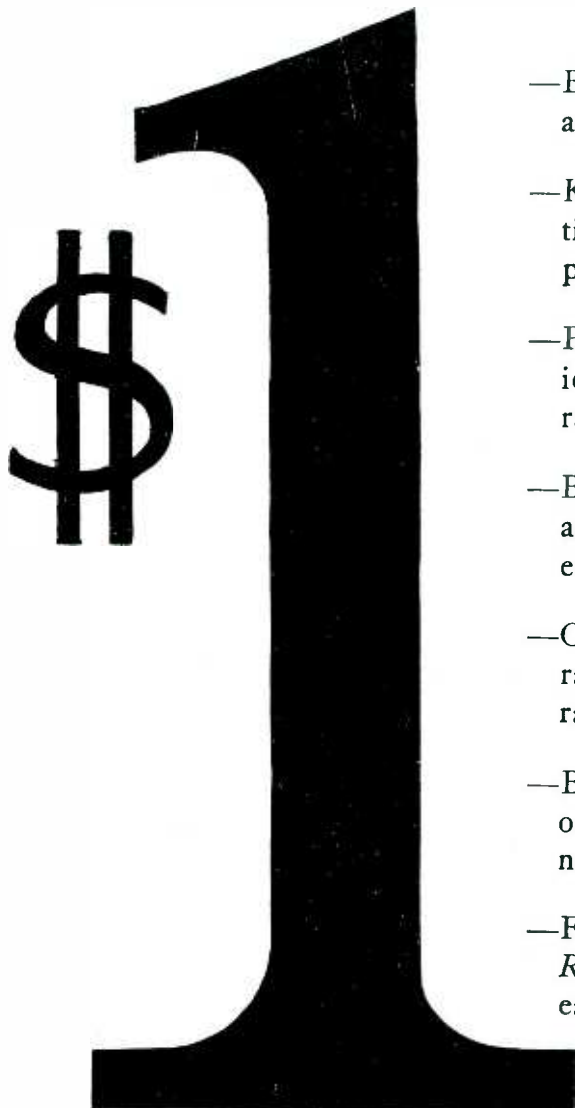

- BRINGS you the leading radio publication for a full year—12 big monthly issues.
- KEEPS your sales methods and service practices right up-to-the-minute through the fact-filled pages of *Radio Retailing*.
- PUTS you in line to get hundreds of usable sales ideas that put extra punch and profit into your radio business.
- BRINGS you practical, time-saving service kinks and shortcuts that take the bugs out of your toughest jobs.
- OPENS the doors to the latest developments in radio design, new circuits, television, automobile radios, phonograph-radio combinations, tubes, etc.
- BRINGS you usable data on store selling, demonstrations, service, new instruments, new circuits, new receiver models, etc.
- FOR 8 1/3 cents a month you can have *Radio Retailing's* unequalled help laid right on your desk each month for a year.

(Every radio dealer, jobber, serviceman and merchant handling radios or tubes owes it to himself to invest in a subscription to *Radio Retailing*. There is no substitute! Order it today!)

FILL IN AND MAIL THIS HANDY COUPON FOR THE BIGGEST BARGAIN IN RADIO

O.K. Attached is \$1. Send me *Radio Retailing* for a full year (12 monthly issues) starting with the current number.

RADIO RETAILING

330 W. 42nd Street
New York, N. Y.

SPECIAL THREE YEAR RATE

Attached is \$2. Send me *Radio Retailing* for 3 full years (36 issues) at money-saving rate.

These subscription rates apply only in U. S. and possessions, Canada, Mexico, Central and South America.



Name Position

Firm Name

Street

City State

Our Main Business Is

This is a renewal order

This is a new order

Pin
—+—
\$1
Here

8-37

S U P R E M E

"The Finest Portable Service Laboratory Ever Built"

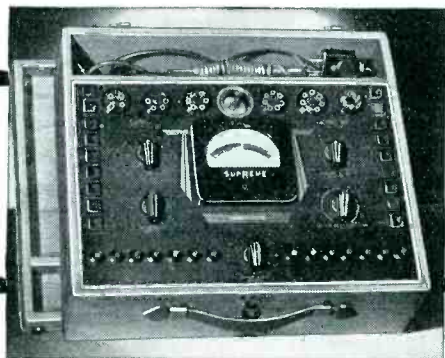

Model 502 TUBE AND RADIO TESTER

When we say that this model is a serviceman's dream come true, we mean just that. Imagine having the Model 501 Tube Tester PLUS nineteen additional ranges and function of 0.2 to 1400 A.C. volts in four ranges; 0.1 ohms to 20 megohms in five ranges; 0.2 to 1400 D.C. volts in four ranges; four output ranges: 0.2 to 1400 A.C. volts. PLUS an Electrostatic capacity leakage test on a neon bulb and PLUS an Electrolytic filter capacity leakage test on a "Good-Bad" English reading scale. A complete, quality tube tester and set tester in a space of 10½" x 5", weighing only 16 lbs. at this new low price.

Dealer's Net Cash Price **\$49⁹⁵**

Or, \$5.50 cash and 10 monthly payments of **\$4.95**

Model 501



Test your customers' tubes more accurately—sell more tubes! That's SUPREME'S new Electro-conductance tube tester. This excellently engineered unit tests tubes for (1) Inter-element leakage between any two elements, (2) open test in any element, (3) short check between any two elements (4) quality test of complete tubes and (5) in the case of tubes having two or more sections, separate sectional quality tests. 5 tests on every tube!

Dealer's Net Cash Price **\$36⁹⁵**

Or, \$4.00 cash and 10 monthly payments of **\$3.66**

Model 551



This extraordinary new model is not only a Set Tester but provides a method of making voltage, current and resistance readings directly from the tube socket without removing the chassis from the cabinet! Analyzes all voltages from 0.2 to 1400 volts A.C. in 4 ranges and 0.2 to 1400 D.C. volts in 5 ranges at 1000 ohms per volt. Three

D.C. current ranges of 0.2 to 1400 mils. Self-contained ohmmeter circuit measures 0.1 to 20 megohms in 5 ranges. 20 functions and ranges in all!

Dealer's Net Cash Price **\$38⁹⁵**

Or, \$4.25 cash and 10 monthly payments of **\$3.86**

Write for new literature describing the complete line!

SUPREME INSTRUMENTS CORP. GREENWOOD MISS., U.S.A.
EXPORT DEPARTMENT, ASSOCIATED EXPORTERS CO.
145 W. 45th ST., NEW YORK, N. Y. CABLE ADDRESS: LOPREH, N. Y.

IT'S A HIT!



The New STANCOR

LINE OF

Battery Operated
VIBRATOR-TYPE
TRANSFORMERS

for

Auto Radios • Rural Radios

Hit! Me eye! It's a HOME RUN. For the Stancor line of Battery-Operated Transformers is the ONLY COMPLETE LINE that can be bought.

Again Stancor leads! Why waste your time and handicap your service by ordering replacements from a dozen sources? Stancor has everything you need! Complete lines of Exact Duplicate and Universal Transformers for every requirement . . . complete assurance of highest quality . . . and a sure profit under Stancor's price policy.

Write for price sheets and complete information.

**S T A N D A R D
T R A N S F O R M E R
C O R P O R A T I O N**

850 Blackhawk Street

Chicago

meter up. Adjust the 75 bias until the meter reads less than one milliamperere. Then switch to the one milliamperere scale and increase the bias until the needle is resting on the first scale division. This is the "false zero" that you work from for VT voltmeter measurement of the oscillator output.

Hook the VT voltmeter input to the r.f. oscillator at point "B" and ground. A dip will be noticed in the meter

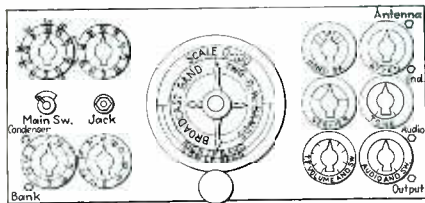

Fig. 3—Panel details and location of control.

needle when swinging over part of the bands. This is caused by unused coils resonating with the coil in circuit. Hook the coil causing the trouble to a switch point on one of the grounded levers. There will be no dips on the lowest frequency IF band but from there on up to the highest frequency band you will get dips until they are eliminated by grounding them out with the switch.

Parts List

- 1 Metal Cabinet
- 1 chassis
- 1 15 inch by 7 inch metal front panel
- 1 input SPST switch
- 2 RFC AC input chokes
- 4 .05 fixed condensers
- 1 midget power transformer
- 1 4 prong wafer socket
- 1 80 tube
- 2 6 prong wafer sockets
- 1 78 tube
- 1 37 tube
- 1 Yaxley No. 1335 switch
- 1 RCA Condenser and dial
- 1 Phone jack
- 6 Yaxley insulated jacks
- 10 bar knobs
- 10 esutcheons
- 1 50 mmf midget
- 5 coils center tapped (All Wave kit)
- 3 cathode resistors
- 1 1 MFD condenser
- 3 .01 condensers
- 1 .1 condenser
- 1 double 4 cardboard electrolytic
- 1 filter choke
- 1 .25 condenser
- 1 3,000 ohm resistor 1 watt for modulator
- 1 100,000 ohm potentiometer
- 1 5,000 ohm potentiometer with switch
- 1 10,000 ohm potentiometer with switch
- 1 100 ohm potentiometer, wire wound arranged to open at one end
- 1 RFC
- 1 audio transformer
- 1 150,000 ohm, 1 watt resistor
- 4 Yaxley 10 point 4 deck switches
- 1 mica .001 condenser
- 1 mica .002 "
- 1 mica .003 "
- 1 mica .004 "
- 1 paper .01 "
- 1 paper .02 "
- 1 paper .03 "
- 1 paper .04 "
- 1 paper .1 "
- 1 paper .2 "
- 1 paper .3 "
- 1 paper .4 "
- 1 paper 1. "
- 1 paper 2. "
- 1 paper 3. "
- 1 paper 4. "

Equalizing Output

One lever of the switch shorts out portion of the cathode resistance on the two short wave bands. This is done to

maintain equal output on these bands. To find out the cathode resistance needed—hook a variable calibrated resistance in series with the cathode. (These resistors are available for service work. IRC builds one type). This calibrated variable resistance in conjunction with the VT voltmeter will tell you the correct cathode resistance to use on each band and the switch can then be used to short out appropriate resistance portions on the high frequency bands.

When the work is completed, you can vary the needle of the VT voltmeter from false zero to the end of the scale on all bands smoothly without dips by varying the 77 screen voltage.

A 37 is shown for the modulator but almost every 6V. tube handy can be used for this position. For pentodes, etc., connect the other elements together to form a triode. Almost all of the tubes except rectifiers will oscillate at audio frequency by connecting as triodes.

Calibrating a Receiver

An easy way to calibrate a receiver on both broadcast and short waves every 100 KC is to plug in an 0.0005 fixed condenser in the jack and vary the tuning condenser until the oscillator oscillates at 100 KC. The harmonics will then give you valuable and handy points every 100 KC.

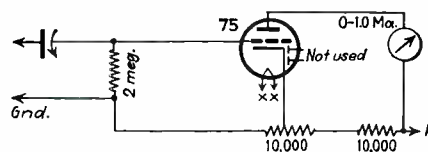

Fig. 4—Suggested schematic for simple vacuum tube voltmeter for testing oscillator.

Tracker Condenser Alignment

By E. Gerald

If when an attempt is made to align a tracker type gang condenser, the oscillator section requires additional capacity of the trimmer at the 1600 KC end, then is found to have too much capacity at 1200 to 800 KC, many times the coils are suspected.

If the screws that hold the stator in place are loosened and the stator pushed down in the condenser so that t.r.f. sections begin to mesh first, the gang condenser will then align. If pushed too far, the oscillator will require additional capacity from the trimmer as the frequency is decreased across the dial. If the oscillator stator is not far enough in the trimmer will require a capacity decrease at 1200 and 1000 KC, after the trimmer is adjusted at 1400 KC.

SHORT CUTS

Repair of Phono-Radio Sets

By H. D. Hooton

The most common trouble encountered in the phonograph portion of the phono-radio installation is weak or distorted reproduction. In cases of this kind it is always a good policy to thoroughly check the performance of the radio amplifier and loud speaker system for faults before making any attempt to repair the phonograph. Frequently the trouble is not in the phonograph proper at all.

In magnetic pickups, the trouble may be due to either the armature being off-center, by hardening of the rubber damping blocks and pivot supports, weak magnets or dust in the airgap. In order to determine whether the armature is properly centered, turn up the phonograph volume control to maximum and move the needle back and forth with the finger. If correctly centered, the same response will be heard when the needle is pushed to either the left or right. If one response is weaker than the other, it will be necessary to loosen the mounting screws and move the damping block plate in the direction of the weak response until the proper adjustment is located. Hardened damping blocks and pivot supports are usually characterized by weak and distorted reproduction accompanied by blasting and rattling on certain frequencies. The usual test for this trouble is to move the needle in each direction as far as it will go, noting the resistance. If the needle moves more easily in one direction than in the other, the damping block and pivot supports need to be replaced.

Weak magnets may cause extremely weak and "tinny" reproduction. The usual test of magnetic strength is to touch the magnet with a steel or iron instrument such as a screw driver, noting the amount of "pull." If the magnet offers little attraction to the screw driver, it must be either replaced or remagnetized as outlined in previous articles appearing in this section. When removing the permanent magnets from either a pickup or speaker, always place a piece of soft iron, such as a bolt or large nail, across the two poles; if this precaution is not observed the magnet may be ruined.

Weak response, accompanied by crackling or fuzzy sounds, may be caused by a partially short-circuited or grounded coil or by dust or dirt in the air gap. If the windings are short-circuiting to the armature or pole pieces, in most cases a repair can be made by prying up the bare turns and applying a few drops of liquid coil dope for insulation. However, it may be necessary to replace or rewind the



600 v. D.C. working. All popular capacities.

Metal-can type inverted-screw mounting. Insulated can.

Cardboard-case type has new Adjustable metal flanges. Any mounting arrangement.

Both types have color-coded leads.

Use them for rush jobs. Carry them in your kit.



Ask for it!

New, big, 32-page catalog. Largest listing of condensers and resistors. Ask your jobber, or write us.



600 V. ELECTROLYTICS

General-utility units of higher voltage rating to take care of troublesome peaks and surges. Added safety margin. • In both metal-can and cardboard-case types. • Small enough to fit almost anywhere.



RED TOP GAS-O-LECTRIC POWER PLANTS

LIST \$98.50



A Sensational Development "2 Plants in 1"

COMBINATION A. C.—D. C.

The new all purpose RED TOP combination A.C. and D.C. light and power plant provides both 110-V., A.C.; 300 watts for lighting, household appliances, small electric tools, and up to 325 watts D.C. for charging 6, 12, and 32-V. batteries. The only practical "2-in-1" gas electric plant for farm, home, trailer, boat, etc. Prices from \$98.50 f.o.b., Chicago. Push button starter.

FOR D. C. ONLY

RED TOP Gas-O-Lectric Power Plants, for charging 6 or 12 volt batteries, 175 watts available at \$54.50 and \$57.95 list. Portable. Efficient. Push button starter. Also other plants from 100 to 2000 watts A.C. or D.C.

Send for dealer discounts and complete literature.

PIONEER GEN-E-MOTOR CORPORATION

Manufacturer of "PINCO" Products

Dept. No. R-1H
466 W. Superior Street
CHICAGO, ILL.

Go RED TOP IN 1957!

A PIONEER GEN-E-MOTOR PRODUCT

Designed to Withstand ROUGH FIELD SERVICING

BUY *Readrite* RANGER

• FOR THAT DUPLICATE SET OF SERVICING INSTRUMENTS ADVOCATED BY LEADING RADIO SERVICEMEN.

• The Readrite-Ranger Model 640 Free Point Tester has eight automatic switch type and ten single action jacks. Five sockets for any type radio tube.

Model 740 Volt-Ohm-Milliammeter has 3" Square Triplett Precision Instrument. Scale readings: 10-50-250-500-1000 A.C. and D.C. Volts at 1000 Ohms per Volt (D.C. Accuracy 2%; A.C. 5%); 1-10-50-250 D.C. M.A.; 0-300 Low Ohms; High Ohms to 250,000 at 1 1/2 volts. (Rheostat adjustment for 13 1/2 volts for Ohm readings to 2 1/2 Megohms.) Batteries may be added permitting such readings in 250,000 Ohm steps. Low Ohms to 1/2 Ohm with 25 Ohms in center of scale. Backup circuit used. Current draw is only 1 M.A.

ALSO AVAILABLE AS SINGLE TESTERS



Model 640-670

COMBINATION VOLT-OHM-MILLIAMMETER AND FREE POINT TESTER No Extra Cases to Buy

PRECISION BUILT ONLY \$28³⁵

READRITE METER WORKS
820 College Dr., Bluffton, Ohio

Please send me more information on Model 640-740; Model 640; Model 740. I am also interested in

Name
Address
City State

SHORTCUTS

faulty coil. Dust may be readily removed from the air gap by means of a small, stiff brush or by blowing it away.

Distorted reproduction is usually caused by the turntable operating unevenly or at an incorrect speed. The speed should be checked by means of a stroboscope disc if possible; if this is not on hand, a small piece of white paper may be inserted between the record and turntable and the speed determined by counting the revolutions per minute. *The pickup needle should be in position on the record during this process.* The correct speed for standard records is 78 revolutions per minute although many phonographs are equipped with a dual-speed turntable for playing the new slow speed 33 1/3 revolutions-per-minute records.

Uneven speed or fluctuations are usually evidenced by a pronounced "wow," especially when playing the slow records. This may be due to excess pressure of the pickup or by hardening of the leather or felt washers upon which the turntable rests. If the difficulty is caused by excess pressure, the counterbalance at the rear of the pickup should be adjusted until the proper balance is obtained. It is usually necessary to replace the washers when the trouble is located here. If

the motor is of the brush-commutator type, the commutator should be cleaned and the brushes carefully refitted by cutting them down with 00 size sandpaper. It is sometimes necessary to oil and grease the motor and check the electrical connections. Sluggish operation of the motor is frequently due to the turntable shaft binding slightly at the point where it passes through the motor assembly. A few drops of sewing machine oil will usually eliminate this trouble.

Sometimes, especially when installing a new motor in a phono-radio, a.c. hum will be heard when playing the records. In most cases the trouble is caused by stray magnetic fields from the motor and can be effectively eliminated by grounding the pickup arm and the motor frame. Most late electric phonographs are constructed in such a manner that the pickup is shielded from the motor field or have hum-bucking coils installed in the pickup. If the trouble appears when a new pickup is installed, it is advisable to place an iron or steel shield under the top of the turntable to prevent the a.c. hum currents from being induced in the pickup windings. It is also advisable to shield the leads from the pickup to the radio and connect the shields to a good ground.



Knock-Down Sound System

By Bob Wright

A portable sound system for mobile or fixed operation is shown in the accompanying sketches. The advantage of such a system is in its ease of installation. The sound man need not own a car; the equipment can be rented "cash and carry."

The sketch is self-explanatory; speakers are bolted to the special frame-

work held in place on the car top by guys to the front and rear bumpers. A piece of heavy cloth or carpet thrown over the roof before the unit is mounted will prevent any scratches.

The amplifier and microphone are carried inside the car so as to be accessible to the operator.

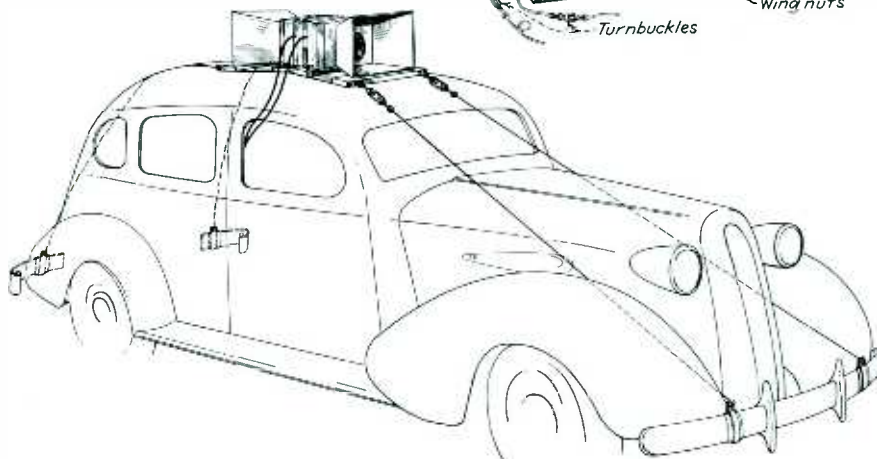
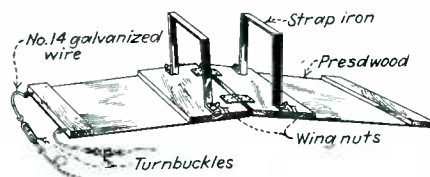

Again ARCTURUS BLAZES the TRAIL

... or Another Reason Why
Critical Dealers and Service-
men Demand ARCTURUS.



Not just a new and smaller rectifier tube but an improvement over anything of its type yet produced... such is the Arcturus engineering record with the 5W4-G. Here's why:

An unique new and exclusive Arcturus construction feature:

1. Eliminates static noise originating in this tube due to vibration and
2. Keeps operating noise at an exceptionally low level.

The design of the glass supporting stem definitely avoids danger of electrolysis. Manufacturing processes assure uniformity of output, long life, and freedom from reverse current which so often causes failure in ordinary rectifier tubes. Then too: the Arcturus actual radio circuit tests doubly guarantee every tube of meeting Arcturus standards—the highest in the field.

Of course the 5W4-G is a new tube type. You probably haven't had much cause to handle it yet. But when you do—play safe. Follow the lead of critical engineers who buy on the basis of tests—not claims. Use Arcturus!

ARCTURUS PIONEERED "G" TUBES
ARCTURUS
RADIOTUBE CO.
Newark, N. J.

ARCTURUS

INDEPENDENT TUBES FOR DEALERS WHO
DO THEIR OWN INDEPENDENT THINKING

SHORTCUTS

Remote Off-On Switch

By Allen Beers

In many homes it is desirable to have provision to quiet the radio during certain occasions. A switch near an armchair or by the telephone saves many steps. It would be impractical to run the 110-v. leads directly from the receiver off-on switch, since fairly heavy current is flowing in this circuit. An a.c. relay and a few pushbuttons will simplify the job.

Referring to the schematic, the relay receives its energy from the line. The "on" buttons, open circuited type, are connected in parallel across the starting and common legs. "Off" buttons, close circuited type, are in series with the running legs. When any of the "on" buttons are depressed, the relay closes.



PEAKING—Cliff Weidenbauer, Jones and Polk, Detroit, goes further; he tunes 'em right on the button with an oscillograph and wobulator.

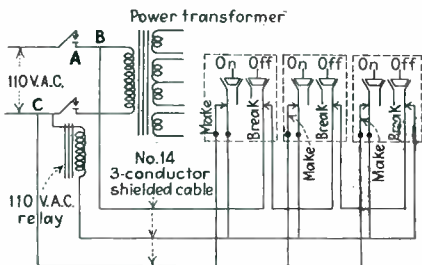

If this button is released the relay still remains closed since the contact A on the relay passes current through the "off" buttons and back to the relay coil. Pressing any of the "off" buttons opens the circuit and the relay falls back to neutral position.

Care must be exercised to follow the diagram carefully at points B and C. If

these connections are made on the wrong side of the relay contacts, the correct action will not take place. Point C should be on the line side while point B is common to the lead to the set. The pushbuttons should be mounted in pairs (off on) in a small box and placed in convenient spots throughout the various rooms.

New laboratory test panels by Triplett

Radio Servicing engineers will welcome these new Laboratory Test, Bench Panels by Triplett. They offer an easy, convenient way of permanently installing and using those instruments which are intended for use at the bench.

Furthermore, Triplett standardization in size makes it thoroughly practical to start with one or more instruments.

Model 1404 has four compartments for Triplett Master Units only. It is compact, convenient and practical. Every dial and control is in full view and easily accessible. The cabinet may be purchased alone or with one or more instruments and lamp. Additional testers may be added to the panel as needed.

Other Models Available

Model 1402 with compartments for any two Deluxe Testers; Model 1403 with accommodations for any two Master Units and one Deluxe Tester.

Models 1402, 1403, 1404—Cabinets Only—Dealer Net Price . . . \$10.00 each.

Model 1499 Lamp only. Dealer Net Price . . . \$6.67.

Cabinets similar to the above but arranged so testers can be removed and used for field servicing also are available. Write for details.

FOR MORE INFORMATION SEE YOUR JOBBER OR WRITE FOR CATALOG

The Triplett Electrical Instrument Co.
208 Harmon Ave., Bluffton, Ohio
New Laboratory Test Bench Panels.

Please send me more information on your
Name
Address
City
State

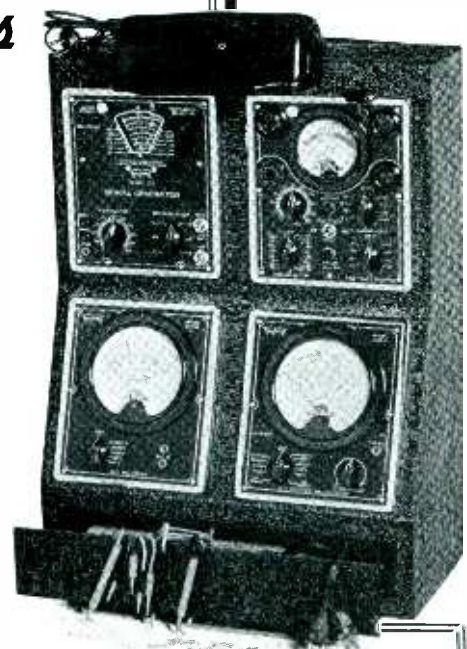

Model 1404
Complete **\$92.18**
(less lamp)

Contains Models

- 1210-A Tube Tester
- 1232 Signal Generator
- 1209-A A.C. Voltmeter
- 1209-D D.C. Volt-Ohm-Milliammeter

TRICKS

APEX 10

Dead, operates with 27 a.v.c. tube out of socket. . . . Replace 1800 ohm section of Candohm resistor at rear of chassis.

APEX 80

Weak, insensitive on one end of dial . . . stator plates have shifted out of alignment. Plates must mesh with the same spacing at top and bottom of plates otherwise oscillation will be prominent at certain settings. To overcome this insert a 500 ohm non inductive resistor directly in the grid lead of the second r.f. tube; also a 250 ohm resistor at the grid of the third r.f.

APEX 36

Normal or excessive volume on high end of dial with little or no volume at other end. . . . Replace open antenna choke and realign.

ATWATER KENT 84

Inoperative . . . shorted oscillator plate tuning condenser at right of chassis.

BOSCH 28

Intermittent . . . leads from stators of tuning condenser shorting to metal frame of tube and coil assembly at points where leads pass through openings. Replace with new leads.

BOSCH 370

Hissing and weak signals . . . open primary in antenna coil.
Weak oscillation . . . open bypass condenser in same circuit (C33)

BRUNSWICK S-14

Noise and motorboating . . . replace grid leads from condenser stators to tube grids, increase tension on phone switch blades. Check local-distance switch if set is dead.

CROSLY 58

Dead. . . . Suspect metal cased condenser containing r.f. plate, screen and cathode bypass (part #W7753). It frequently shorts out, sometimes burning one or both of the Candohm resistors at the back of chassis. As a safety first measure solder the speaker plug to its socket connections under chassis. This is a constant source of noise and intermittent reception as plug often works loose.

PERFECT FOR SOUND TRUCKS
Yet Can Be Used Anywhere

MP 530 Has

- Plug-in Power Pack for either 6 Volt DC or 110 Volt AC operation
- Hand Type Crystal Microphone
- Phonograph and High Fidelity Pickup Built in Amplifier
- Two Heavy Duty P.M. Speakers
- Mixes Microphone and Phonograph, Tone Control also incorporated

Economically Priced

Model MP-530 is designed to answer the problem of one sound system that will perform anywhere. This is the one system that all dealers should own. It will take care of any kind of rental demand, inside auditoriums, outside pavilions, sound trucks, roadside stands, camps, water fronts. Handles any size to approximately 5000 people—outdoors—twice this number indoors.

Everything you need is included—even a phonograph is built into the amplifier. . . . Get into this fast-growing sound market today.

WEBSTER-CHICAGO
60 WATT AMPLIFIER

This amplifier is a five-stage, 12-tube, high gain design, with a four position and master control. An up-to-the-minute high power mixer with four input controls having position for elaborate installation having up to four microphones and phonograph input. System is designed for increasing power in multiples of 60 watts by paralleling additional power stages. Thoroughly suitable for indoor or outdoor work, handling audiences of 12,000 to 20,000—depending on conditions.

STRICT DEALER POLICY

See Your Jobber

Write For Catalog

WEBSTER-CHICAGO

Section AU-8, 5622 Bloomingdale Ave., Chicago, Illinois

Name _____ State _____

Address _____

City _____

...Please send me more information on Model MP-530 All Purpose Sound System. . . . Model 4P-60 Amplifier.

34

**PERMO DYNAMIC
SPEAKERS FROM
WHICH TO CHOOSE**

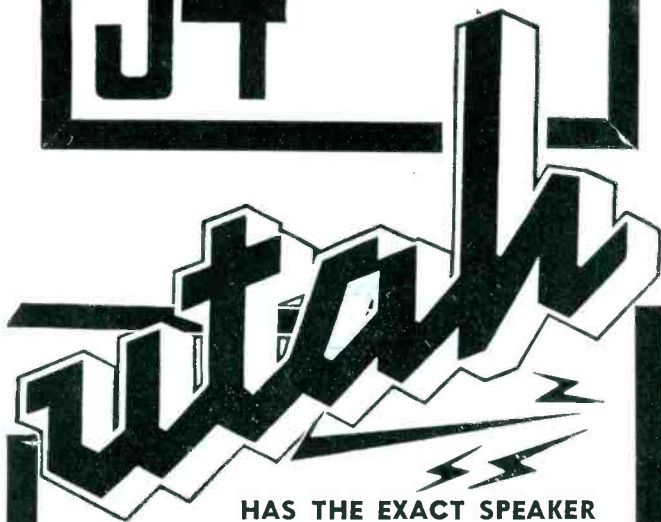

**HAS THE EXACT SPEAKER
FOR EVERY SOUND
REQUIREMENT**

Now you can meet every permanent magnet speaker requirement with one of UTAH'S new models. The same line that reaches a new high in performance, has been expanded to provide the exact speaker for every job.

Cone diameters range from five to fourteen inches, with output capacities as high as thirty watts. All are conservatively rated. Remarkable frequency response provides glorious tone. This complete line, attractively priced provides profitable opportunities for you. Address Department RR8 for details on all 34 UTAH Permo Dynamic Speakers. Write today!

**HERE'S WHY UTAH TRANSFORMERS
IMPROVE RADIO PERFORMANCE!**



No back talk from UTAH transformers! Elimination of feedbacks is just one reason why "Hams" prefer UTAH. Write for details.

- ✓ Lower eddy current losses, with less consequent heating.
- ✓ Greater magnetic field efficiency due to special transformer core materials and unique design.
- ✓ Unusually high safety factors in both insulation and design.
- ✓ Positively sealed against humidity.

UTAH RADIO PRODUCTS CO.
CHICAGO, U. S. A.

TORONTO ONTARIO, CANADA BUENOS AIRES (UCOA RADIO PRODUCTS CO.)

"16 YEARS OF LEADERSHIP"

**"ASK ANY MECHANIC"
he'll tell you**

**IF IT'S QUALITY
YOU'RE
LOOKING FOR,
REMEMBER
THE NAME
KRAEUTER**



If you want to get ahead in this game, remember this—you can't do a good job with poor tools. It pays to buy the best.

The Krauter Line has always been the favorite of experienced radio mechanics. And these tools will help YOU turn out better work with less time and trouble. For full information write: Krauter & Company, Dept. "R".

No. 4601 — ELECTRICIANS' DIAGONAL CUTTING PLIERS made especially for close cutting. Forged from special plier steel and precisely fitted for exact work. Sizes 4½" to 7½".

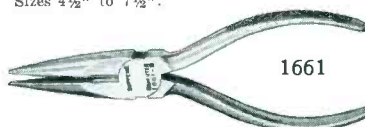
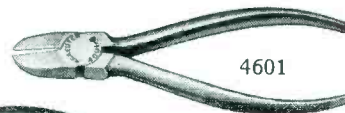

No. 1661 — NEEDLE NOSE SIDE CUTTING PLIERS. A fine slender nosed, tapered point plier especially handy for the radio manufacturer or repair man. 6" only.

No. 1831 — ELECTRICIANS' HEAVY DUTY PLIERS. Just the thing for general wiring work. Strongly constructed with sturdy wire cutters. 4" to 8" sizes.

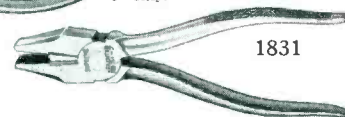

KRAEUTER & CO., Newark, N. J.
(Pronounced KROY-TER)

Manufacturers of Highest Quality Pliers and Tools Since 1860

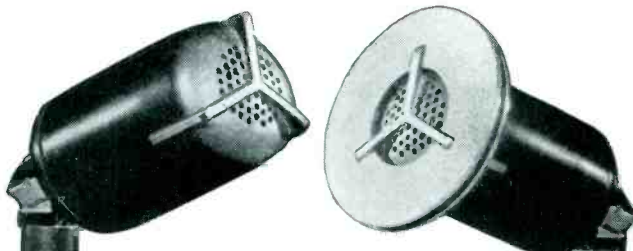

**TOP QUALITY
at
BOTTOM PRICE**

The "Salt-Shaker" assures typical Western Electric performance, either as a non-directional mike (left) or as a directional mike (right). Putting on or taking off the acoustic baffle takes only a moment.

Dealers: use and specify this 2-in-1 mike for public address work. Its low price will surprise you!

**Western Electric
2-in-1-MIKE**

GRAYBAR ELECTRIC CO., Graybar Building, New York. Please send me new bulletin on Western Electric 633A Microphone. HR-8-37

Name _____
Address _____
City _____ State _____

the AMPERITE VELOCITY with NEW DESK STAND

the
LEADING VALUE IN P. A.
EQUIPMENT TODAY!

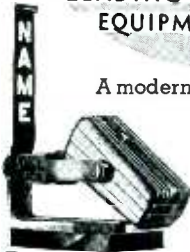

A modern, versatile combination. Ideal for Desk, Pulpit, Footlights, Banquets. Leaf spring suspension acts as extra shock absorber.

**STAND ONLY
LIST \$4.00**

Name Plate with maximum of 10 letters.
LIST \$2.00

Microphones:

Models RBHn (High Imped.); or RBMn (200 ohms); with Cable Connector & Switch . . . **LIST \$42.00.**

Models RBSn, RSHn, streamline design, slightly lower output than above, with switch only . . . **LIST \$32.00.**

NEW "HAM MIKE"

No Peaks! No Splashing! Real Broadcast Quality!

RF CHOKE CIRCUIT INCLUDED IN MICROPHONE

Finest mike ever designed for "hams". No peaks, thereby allowing a higher percentage of modulation without splashing. Output, -68 db. Operates directly into grid of tube. Rugged. Not affected by climate or pressure changes.

MODEL HAM (High Imped.) or **MODEL HAL** (200 Ohms) Gunmetal, **LIST \$22..** Chrome, **LIST \$23.00.** Price includes special Ham Desk Stand with individual call letters, and 6 feet of cable.

AMPERITE MODEL RAL

A popular Amperite **\$22 LIST** Velocity of very high excellence. Used for both speech and music. No peaks. Flat response over audible range. Output, -68 db. Triple shielded. Fitted with shock absorber and swivel bracket. **MODEL RAL** (200 ohms) with 8 ft. of cable; **MODEL RAH** (2000 ohms) high impedance, with 12 ft. of cable. Gunmetal, **LIST \$22.00** Chrome. **LIST \$23.00**



FREE: Window Decal & Window Display

AMPERITE 561 BROADWAY, N. Y.
Cable Address: Alkern, New York

AMPERITE Velocity
MICROPHONE

T R I C K S

CROSLLEY 120

No reception, background noises but not signals. . . . Shunt 2000 ohm resistor across divider section supplying oscillator plate.

CROSLLEY 715

Intermittent reception accompanied by oscillation. . . . If set operates normally when finger is placed on grid cap of 2B7 tube at rear of chassis replace defective 3 section filter condenser (part #36056).

EVEREADY 50 SERIES

Motorboating at high volume Check screen grid divider (part No. 2996). Replace with a 20 watt wire-wound unit.

FADA RK 100

Interference check leads from power unit to receiver. They are in a metal shield which should be grounded to car frame.

GENERAL MOTORS 110

Mushy tone. . . . Replace 250,000 ohm detector load resistor.

GLORITONE 26

Low volume change 45 output tube to 2A5. Bias resistor should be 400 ohms at 2 watts. Bypass with 5 mfd 35 V. electrolytic condenser.

LYRIC S-8

Low volume accompanied by crackling. . . . Replace .002 mfd. condenser connected from second detector plate to cathode. Excessive oscillation on high end of dial can be remedied by replacing 0.1 mfd. condenser connected to oscillator coil at top between first detector grid and oscillator coil. Realign set.

MOTOROLA 34

Noisy tighten i.f. coil shields. These are fastened to the chassis with self tapping screws.

PHILCO 18

Dead check tone control condenser for short.

PHILCO 37-10

Intermittent oscillation check 32,000 ohm resistor under the oscillator coil section for increase in value. Replace with new 32,000 ohm unit.

ANNOUNCING
THE NEW
PRESTO
JUNIOR
PORTABLE
RECORDER



HALF THE SIZE
20" x 15" x 10"

HALF THE WEIGHT
35 Pounds

HALF THE PRICE
of any Presto sound
recorder ever made.

The machine that will close sales for hundreds of dealers whose customers are asking for a low priced home recorder.

The Presto Junior Recorder makes high quality phonograph records that can be played 50 to 100 times with ordinary steel needles on any phonograph. It plays any phonograph record. It is sold complete with microphone. It connects to any radio set to record programs off the air.

ORDER NOW FOR
OCTOBER DELIVERY

PRESTO
RECORDING
CORPORATION

143 W. 19th St., New York

... *Endorsed*
BY LEADING SERVICE ORGANIZATIONS

★ ★
HIGHEST QUALITY
 ★ ★
HIGHEST PROFIT
 ★ ★
FREE EQUIPMENT
NATIONAL UNION RADIO TUBES

National Union manufactures a complete line of radio tubes—glass, metal and G-type. National Union's high quality has made them outstanding favorites in the radio service profession. All sales policies have been formulated with the idea of making National Union radio tubes the ideal replacement tube for the radio dealer. This has been backed up with a selling program that means real support and help to the wide-awake dealer. Dealers and jobbers handling National Union radio tubes are the leaders in repair parts and service.



This "Sign of Efficiency" Can Help You, Too. Get It **FREE** from N. U.

SEE YOUR JOBBER

FREE EQUIPMENT INCLUDES:

Tube testers, set analyzers, oscillographs, signal generators, modulators, meters and other servicing instruments. In shop equipment items available include stock cabinets, coats, display signs, electric clocks, etc. All items absolutely free the National Union Way.

The National Union Way

Through National Union's help, radio service dealers everywhere have been able to set up better equipped shops to do better work; also to obtain merchandise helps that produce more customers. National Union has constantly put the latest advances in scientific equipment as well as modern selling aids within reach of the service dealer. The National Union Deal calls for a dealer deposit which is rebated when the specified number of tubes have been purchased. Over 70,000 completed deals. Every service dealer should investigate.

THE ROAD TO BETTER BUSINESS

1. Full guarantee on highest quality radio tubes.
2. Cut price business not solicited.
3. Price Protection.
4. N. U. jobber stocks are complete. No hunting for odd types.
5. Timely business building aids.

Clip! Mail Now!

NATIONAL UNION RADIO CORPORATION
 570 Lexington Ave., New York City

RR-837

Tell me how I can get the Sign of Efficiency Free. Name

I am also interested in the following equipment. Address

City..... State.....

Hungry Vibrators



In Ye Olden Days before the discovery of proper buffer and transformer vitamins—
HUNGRY VIBRATORS THAT ATE POINTS NEEDED EIGHT POINTS

Radiart made some of these several years ago.

● Today Radiart furnishes you with the same kind of vibrator that they furnish directly to the manufacturers, whose tests have proved what is best for their own sets.

● Play safe—for Exact Duplicate Vibrators insist on Radiart from your dependable Radiart Jobber.

COMING NOV. 10TH RIDER VOL. VIII MANUAL



YOU NEED THE UP-TO-DATE KNOWLEDGE IN THESE TWO New RIDER BOOKS TO SERVICE UP-TO-DATE RECEIVERS

AUTOMATIC FREQUENCY CONTROL SYSTEMS

With Automatic Frequency Control Circuits in many new higher-priced models, knowledge of "AFC" means money in your pocket!

Learn the practical facts, from the easy to understand explanations by John Rider. Get your copy today and have the timely information enabling you to cash in on profitable "AFC" repair work.



HARD COVERS 144 PAGES \$1.00

VIBRATOR POWER SUPPLIES

by GARSTANG and RIDER

It becomes increasingly important that servicemen have the information on vibrator supply systems which is contained in this book. For vibrators are

used in auto radio sets, 32-volt farm receivers, mobile P. A. systems, coin operated phonograph and radio sets, etc., etc.

280 Pages—Profusely Illustrated—Hard Covers \$3.00

JOHN F. RIDER, Publisher, 1440 Broadway, New York

YOU NEED ALL 8
Rider
MANUALS

TRICKS

PHILCO 806, 807, 808, 809, 816,
817, 818, 819

Vibrator hash . . . insert an iron core "A" choke in series with the speaker field. Choke must be of low resistance and a few henries inductance.

PHILCO DODGE

Insensitive on rod antennas . . . remove shield can on side of set to which antenna is connected and short small choke found in series with antenna lead. Realign first r.f. stage.

RADIOLA 48

Intermittant . . . examine plates of variable condenser for filings. The plates of this condenser are made of a magnetic material and should be kept clear of filings. Blow out thoroughly with air pressure.

RCA VICTOR 100

Low volume . . . leaky antenna coupling condenser which blocks the a.v.c. action. Replace with similar higher voltage unit.

RCA VICTOR 120

Motorboating, no signals . . . check for open condenser in three section electrolytic block located to right of gang condenser. The offender is usually the screen grid bypass.

RCA 331

Strong buzzing . . . connect a .001 mfd condenser from center terminal of volume control to the side lug of control that connects to 60,000 ohm resistor. This will bypass excess r.f. currents.

RCA D-22-1 Volume Expander

Lack of expansion, drop in volume when expander is turned on . . . replace part #11608 consisting of two 1 mfd and one 4 mfd condensers. These are C-208, C-209, and C-210 in the schematic. Also check R-203, a 100,000 ohm resistor in the plate circuit of the 6L7 for drop in resistance. If operation still unsatisfactory check C-201, C-202, and C-206.

Excessive hum with switch in phone position can be remedied by replacing C-106, an 18 mfd condenser (part #11496) in the plate circuit of the 6C5 first audio stage.

RADIO RETAILING, AUGUST, 1937

THE C-D EQUATION for Greater Profits

BETTER QUALITY CONDENSERS
BETTER PRODUCT MERCHANDISING
GREATER PROFITS

Cornell-Dubilier Electric Corporation is the only organization that produces a complete line of condensers for every requirement. We invite you to write for details.

HERE IS THE
C-D

PLUS PROFIT LINE FOR
YEAR ROUND SALES
DRY ELECTROLYTICS

in tubular, cardboard, aluminum and silvered containers. Many other types to fill your every need.

PAPER CAPACITORS
bypass and filter, "dwarf-tiger" tubulars, and others for high and low voltage applications.

MICA CAPACITORS
for receiving circuits, low loss R.F. bypass and blocking high voltage and heavy current micas for broadcast transmitters.

DYKANOL CAPACITORS
for amateur and broadcast station applications.

WET ELECTROLYTICS
for both panel and sub-panel mounting in a complete capacity range at voltages up to and including 500 volts.

CORNELL-DUBILIER
ELECTRIC CORPORATION
South Plainfield, New Jersey

Telling the engineer and manufacturer
what is being done with electron tubes
in industry—and how it is being done

Just published — New second edition

Electron Tubes in Industry

by KEITH HENNEY, Editor, *Electronics*
539 pages, 6 x 9, 397 illustrations, \$5.00

ENGINEERS and manufacturing executives interested in cheapening or quickening industrial processes will find in this book a thorough presentation of the practical aspects of electronics—what the electron tube is doing toward making processes simpler, cheaper, safer, and in making possible new methods of control. Describes in detail amplifier, rectifier, and other tubes and photocells and their applications in industry, including circuit diagrams, performance charts, and comparisons with other types of apparatus.

See this edition for
developments in:

- circuits using newer tubes, elements and principles
- motor control, welding, illumination, and register control
- ignitron tubes, cathode-ray tubes, and other types
- capacity relays, relay circuits
- application of tubes to power conversion, inversion, and transmission
- invisible light control methods, etc.

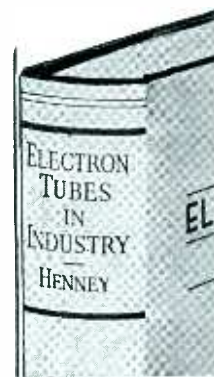

SEND THIS ON-APPROVAL EXAMINATION COUPON

McGRAW-HILL BOOK COMPANY, INC.
330 West 42d Street, New York, N. Y.

Send me Henney's *Electron Tubes in Industry* for 10 days' examination, on approval. In 10 days I agree to pay \$5.00 plus a few cents postage and delivery, or return book postpaid. (We pay postage on orders accompanied by remittance.)

Name

Address

City and State

Position

Company

(Books sent on approval in U. S. and Canada only.)

FRR-8-37



• Midget Size
ELECTROLYTIC CONDENSERS

Compact, highest quality G.H. electrolytics . . . unsurpassed efficiency . . . space saving units . . . full ratings.

Complete quality line of paper and electrolytic condensers, can and cardboard, single and multiple sections. Standard sizes and shapes for every make of radio and for P.A. and transmitting use. Complete line of Carbon Resistors. Write for descriptive literature.

Territories, with attractive concessions, available to Jobbers.

GIRARD - HOPKINS

1437 23rd Ave.

Oakland, Calif.

Announcing the **NEW 1938 REMLER**

32 Watt Power Amplifier



The new Remler AP2-184 is a high fidelity, two channel power amplifier designed for Public Address, paging systems and centralized sound installations where more than usual power is required.

The unit is a push-pull 6L6G beam tube amplifier. 9 tubes—32 watt output; ample gain for sound cell crystal or for high impedance dynamic or velocity microphones. Two high impedance inputs with individual pre-amplifier tube and volume control.

Auxiliary independent phonograph input for low impedance pick-up; electronic mixing; dual tone control for bass or treble compensation. Attractive brushed-dural panel, black wrinkle-enameled case. List price

\$140

REMLER COMPANY, Ltd.

19th at Bryant

San Francisco

REMLER—THE RADIO FIRM AS OLD AS RADIO

INTRODUCING



Keep your customers satisfied! Ninety per cent of service calls are caused by condenser breakdown, so why jeopardize customer good will and create a flock of profitless "call-backs" by using inferior condensers. Use GLASSMIKE the condenser that's absolutely impervious to moisture, and *guaranteed* for a year. It's new, different, sealed in a glass tube, and it costs no more than ordinary condenser. Ask your jobber for GLASSMIKE—write today for descriptive circular with specifications.

**ASK YOUR JOBBER
to Show You "GLASSMIKE"**

CONDENSER PRODUCTS CO.
1369 NORTH BRANCH STREET
CHICAGO • ILLINOIS

What's Radio Retailing Say?

If you read it in RADIO RETAILING it is true—and timely.



That goes for both the editorial and the advertising contents of this, the radio industry's recognized leading publication!

**RADIO
RETAILING**

330 W. 42d St., New York, N. Y.

THE Eyes HAVE IT!

*Solar
Capacitor Analyzer*

Your eyes and the MAGIC TUBE . . . see all, know all, troub as a walk!

Write for Descriptive Literature

SOLAR MFG. CORP. 330-421 Broadway New York, N. Y.

TRICKS

RCA T-8-14

Oscillation. . . . Grid leak on rear top of main tuning condenser has changed its resistance. Replace with identical unit.

U.S. 27

Intermittent . . . leakage in wet electrolytics. Liquid on top of can causes short between positive terminal and can. Mount with vents on top. If boiling still persists replace both 8 mfd sections.

"BULLET" MIKES

. . . New 1938 Models Now Ready—Get Details



When our engineers created the new 1938 "Bullet" dynamic microphones they built a line unsurpassed in quality and performance. "Bullet" mikes are remarkably sensitive, rugged and dependable. You who appreciate fine quality in sound reproduction will do well to get complete data on the new "Bullet" line. Models TR-5, 6, 7, 8 and 9 range in list price from \$27.50 to \$90.00. There's a model to fill your need. For complete data and prices, write now to Dept. IR.

Some territories open . . . if you are a distributor—ask.



"BULLET" MICROPHONES

Made only by

TRANSDUCER CORPORATION
30 Rockefeller Plaza New York

VICTOR R32

Noisy volume control . . . when replacing controls in this set use a 10,000 ohm unit. Disconnect the brown resistor that biases the 26 r.f. tubes and connect to one side of new control. Connect antenna to other side, ground center arm. This change will increase selectivity and give the control longer life.

WELLS GARDNER 24

Poor tone, weak . . . replace .01 mfd. 360 v.d.c. condenser (part No. 46 x 120) with 600 volt unit.

WELLS GARDNER OEL

Distortion on strong stations when tuned exactly to resonance, reception normal when detuned slightly. . . Balance i.f. as one transformer is badly out of alignment.

ZENITH 91, 92

Inoperative until 24A a.v.c. is removed . . . open a.v.c. voltage divides connect 15,000 ohm 1 watt wire wound resistor across that section which is between cathode and screen grid tops.

ZENITH 805, 807, 809

Fading or distortion . . . Replace leaky .02 mfd. coupling condenser to 42 output tube. Also check 42 tube.

ZENITH 4V131, 4B31

Inoperative. . . This set will not operate if pilot light is burned out. It is connected in series with the two 15 tubes. Replace with a 2.9 volt bayonet type bulb. Must be exact replacement for proper operation.

Noisy. . . Replace 15 tube in first r.f. stage. Many times this tube tests perfect, replacement is only way trouble can be found

ZENITH 6B129

Distortion. . . . Replace 8 mfd. filter condenser in power pack. Capacity of this unit has decreased.

ZENITH P-71

Dead . . . shorted filter section on either side of choke coil. Cut shorted lead, connect 8 mfd electrolytic with *negative* side to choke; positive lead goes to connector strip.

ARISTON

★QUALITY PRODUCTS, such as Ariston Speakers and Condensers are not produced overnight. Many years' experience, plus sound engineering, are imperative factors in obtaining SERVICE free from interruptions.



The choice of many leading manufacturers—it is easy to see the reason—quality all the way through. Use the coupon to obtain catalog.

ARISTON MFG. CORP.
4045 DIVERSEY AVENUE, CHICAGO, ILL.
PLEASE SEND CATALOG

NAME
ADDRESS
CITY STATE
JOBBER DEALER

MILLIONS IN USE  THEY DO THE WORK

Go To Town With FLYERS

"INCREASED volume of fall business in Radio-Phonographs," say reliable observers of buying trends. Be ready. Equip your sets to get the takers—install General Industries FLYER Motors. Engineered and built for the fine accuracy of speed, regardless of variations in record drag, that *sells sets and records*. Famous for long, trouble-free service, because precision built for world-wide demand.

The **GENERAL INDUSTRIES CO.** 3737 Taylor St. ELYRIA, OHIO



FLYER Motors are self-lubricating, with silent laminated bakelite gears and long over-size bearings. They are priced surprisingly low. Order a test motor NOW. Be sure to specify whether AC or DC, also exact voltage and frequency of current you use.

INDEX TO ADVERTISERS

AUGUST 1937

	Page		Page		Page
AEROVOX CORP.	68	INTERNATIONAL RADIO CORP.	27	SENTINEL RADIO CORP.	45
(Condensers)		(Radio Sets)		(Farm Radio Sets)	
AMPERITE CO.	73	JANETTE MANUFACTURING CO.	58	SOLAR MANUFACTURING CO.	76
(Microphones)		(Rotary Converters)		(Condensers)	
ARCTURUS RADIO TUBE CO.	69	KRAEUTER & CO.	72	STANDARD TRANSFORMER CO.	66
(Tubes)		(Servicemen's Tools)		(Transformers)	
ARISTON MANUFACTURING CO.	77	MALLORY & CO., INC., P. R.		STEWART WARNER... 20A, 20B, 20C, 20D	
(Speakers)		Inside Front Cover		(Refrigerators)	
BENDIX HOME APPLIANCES		(Replacement Parts & Power Packs)		STROMBERG CARLSON TELE. MFG.	
28A, 28B, 28C, 28D		MAJESTIC RADIO & TELEVISION		CO.	2
(Home Laundries)		CORP.	52	(Radio Sets)	
BREEZ-ELECTRIC CO.	58	(Radio Sets)		SUPREME INSTRUMENT CORP.	70
(Wind-Electric Chargers)		McGRAW-HILL BOOK CO.	75, 79	(Test Equipment)	
BRIGGS & STRATTON CORP.	10	NATIONAL UNION RADIO CORP.	74	TRANSDUCER CORPORATION.	77
(Gas Engines & Generators)		(Tubes)		(Microphones)	
CONDENSER PRODUCTS CO.	76	NOBLITT-SPARKS INDUSTRIES, INC.	30	TRIAD MANUFACTURING CO.	58
(Replacement Condensers)		(Radio Sets)		(Tubes)	
CONTINENTAL MOTORS CORP.	5	OPERADIO MANUFACTURING CO.	44	TRIPLET ELECTRICAL INSTRUMENT	
(Chargers)		(Inter-Communicating Systems)		CO.	70
CONTINENTAL RADIO CORP.	40, 41	PARRIS-DUNN CORP.	57	(Test Equipment)	
(Radio Sets)		(Wind-Electric Chargers)		TUNGSOL RADIO TUBES, INC.	63
CORNELL-DUBILIER CORP.	75	PIONEER GEN-E-MOTOR CORP.	68	(Tubes)	
(Condensers)		(Electric Plants)		UTAH RADIO PRODUCTS CO.	72
CORNISH WIRE CO.	53	PRESTO RECORDING CORP.	73	(Vibrators)	
(Antennas)		(Recording Equipment)		WARD PRODUCTS CO.	56
CROSLEY RADIO CORP.		RADIART CORP.	74	(Auto-Radio Antennas)	
(Radio Sets) Inside Back Cover		(Vibrators)		WEBSTER-CHICAGO	71
CROWE NAME PLATE & MFG. CO.	59	RADIO RETAILING MAGAZINE	46	(Sound Equipment)	
(Auto-Radio Controls)		(Trade-In Allowance Manual)		WESTERN ELECTRIC CO.	72
ELECTRONIC LABORATORIES, INC.	52	RAYTHEON PRODUCTION CORP.	35	(Microphones)	
(Converters)		(Tubes)		WILCOX-GAY CORPORATION.	6
FAIRBANKS-MORSE HOME APPL.		RCA MANUFACTURING CO., PARTS		(Radio Sets)	
CORP.	36	DIVISION	56	WILLARD STORAGE BATTERY CO.	43
(Radio Sets)		(Antenna Systems)		(Storage Batteries)	
GENERAL ELECTRIC CO.	Back Cover	RCA MANUFACTURING CO., RA-		WINCHARGER CORP.	8
(Radio Sets)		DIOTRON DIV.	5	(Wind-Electric Chargers)	
GENERAL INDUSTRIES CORP.	77	(Tubes)			
(Radio-Phonograph Equipment)		RCA MANUFACTURING CO., SET			
GIRARD-HOPKINS	76	DIVISION	Front Cover		
(Condensers & Resistors)		(Radio Sets)			
HOWARD RADIO CORP.	3	READRITE METER WORKS.	68		
(Radio Sets)		(Test Equipment)			
HYGRADE-SYLVANIA CORP.	9	REMLER CO., LTD.	76		
(Tubes)		(Inter-Communicating Systems)			
		RIDER, JOHN F.	74		
		(Service Manuals)			
		RURALITE CORP.	59		
		(Wind-Electric Chargers)			

SEARCHLIGHT SECTION

Classified Advertising

Classification	Page
CATALOGS	79
WANTED TO PURCHASE	79
RADIO STOCKS	
G & G Majestic Refrig. & Radio Parts	
Service	79
Radolek Co.	79

McGRAW-HILL PUBLISHING COMPANY, INC. Publication Office: 99-129 North Broadway, Albany, N. Y. Editorial and Executive Offices: 330 West 42d Street, New York, N. Y. Branch Offices: 520 North Michigan Avenue, Chicago; 883 Mission Street, San Francisco; Aldwych House, Aldwych, London, W. C. 2; Washington; Philadelphia; Cleveland; Detroit; St. Louis; Boston; Atlanta, Ga.

Now—A high-powered

RADIO ENGINEERING LIBRARY

—especially selected by radio specialists of McGraw-Hill publications

—to give most complete, dependable coverage of facts needed by all whose fields are grounded on radio fundamentals

—available at a special price and terms.

THESE books cover circuit phenomena, tube theory, networks, measurements, and other subjects—give specialized treatment of all fields of practical design and application. They are books of recognized position in the literature—books you will refer to and be referred to often. If you are a researcher or experimenter—if your interest in radio is deep-set and based on a real desire to go further in this field—you want these books for the help they give in hundreds of problems throughout the whole field of radio engineering.

5 volumes, 3064 pages, 2000 illustrations

1. Glasgow's PRINCIPLES OF RADIO ENGINEERING
2. Terman's MEASUREMENTS IN RADIO ENGINEERING
3. Chaffee's THEORY OF THERMONIC VACUUM TUBES
4. Hund's PHENOMENA IN HIGH-FREQUENCY MEASUREMENTS
5. Henney's RADIO ENGINEERING HANDBOOK



New
The Library now comprises a revised selection of books culled from latest McGraw-Hill publications in the radio field.

Special Low Price Easy Terms

Bought singly, the five volumes comprising this library would cost you \$26.00. Under this offer you save \$2.50 and, in addition have the privilege of paying in easy installments beginning with \$2.50, 10 days after receipt of the books, and \$3.00 monthly thereafter. Already these books are recognized as standard works that you are bound to require sooner or later. Take advantage of these convenient terms to add them to your library now.

McGRAW-HILL ON-APPROVAL COUPON

SEND THIS ON-APPROVAL COUPON
McGRAW-HILL BOOK COMPANY, INC.
330 West 42d Street, New York, N. Y.

Send me Radio Engineering Library 5 vols. for 10 days' examination on approval. In 10 days I will send \$2.50, plus few cents postage, and \$3.00 monthly till \$23.50 is paid, or return books postpaid. (We pay postage on orders accompanied by remittance of first installment.)

Name

Address

City and State

Position

Company FRR-8-37
(Books sent on approval in U. S. and Canada only.)

SEARCHLIGHT SECTION

(Classified Advertising)

EMPLOYMENT: "OPPORTUNITIES": EQUIPMENT
BUSINESS: : USED OR RESALE

UNDISPLAYED — RATES — **DISPLAYED**

15 CENTS A WORD. MINIMUM CHARGE \$3.00
Positions Wanted (full or part time salaried employment only) ½ the above rates payable in advance.
Box Numbers—Care of publication New York, Chicago or San Francisco offices count as 10 words.
Discount of 10% if full payment is made in advance for consecutive insertions.

Individual Spaces with border rules for prominent display of advertisements.
1 inch \$8.00
2 or 3 inches 7.80 per inch
4 to 7 inches 7.60 per inch
An advertising inch is measured vertically on a column—3 columns—30 inches to a page. Contract rates on request.

\$500,000 GENUINE MAJESTIC-GRIGSBY GRUNOW REFRIGERATOR & RADIO PARTS. 2000 REFRIGERATOR UNITS

MAJESTIC

UNITS GUARANTEED 18 MONTHS. SEND FOR PRICE LIST. G & G GENUINE MAJESTIC REFRIGERATOR & RADIO PARTS SERVICE
5801 W. DICKENS AVE. CHICAGO, ILL.

WANTED USED AUTO RADIOS

We Pay Cash For Working or Non-Working Sets—Write
KARAMUS SALES & EXPORT
557 E. Curtis Street Linden, N. J.



STOP SEARCHING! HERE IS YOUR "GUIDE"

SEND FOR THE NEWEST BOOK IN RADIO!

Here is the solution to all your radio supply problems... Here is your key to the fastest service... Lowest Prices... and the largest stock of Radio Repair Parts in the world! This Radolek new 1937 Radio "Profit Guide" is the most complete and up-to-date Radio Parts Catalog ever published... over 160 pages... bringing to you over 12,000 individual Repair Parts... hundreds of new items... a complete new selection of Radio Receivers, Amplifiers, Tubes, Tools, Books, and Instruments... Everything you need... always in stock... Radolek gives you what you want when you want it and at the right prices... Send for your FREE copy of this big New Book NOW!

AUTO RADIO HEADQUARTERS

EVERYTHING IN AUTO RADIO—at the right Prices...
Universal control heads... Dash mounting adapted Kits...
Every type auto aerial... Cables and fittings...
Complete vibrator guide... Everything you need...
Ready for prompt shipment.



FASTEST SERVICE

COMPLETE STOCKS

LOWEST PRICES

Rely on Radolek for "Everything in Radio"

RADOLEK

601 W. Randolph St., Dept. A-10, CHICAGO

Name

Address

Serviceman? Dealer? Experimenter?

LETTERS

Competitive Catalogues

Being interested in sound equipment as a manufacturer's agent there is one thing I would like to see *Radio Retailing* and other magazines do. That is to eliminate from its list such concerns as _____ and other such mail-order houses that mail their books out to just about anyone that wants to receive them.

If we are to ever clean up the sound equipment business and maintain list prices to consumers this type of catalog has got to go. Dealers in every community find such catalogs their worst competitors.

MINNEAPOLIS

M. E. FOSTER

New Business

We are forming a company to job recording, public-address, amplifiers and allied equipment.

Our aim is to buy for cash and carry a medium stock at first. We believe the merchandise listed above will be among the fastest growing in the business.

Would appreciate it very much if you would advise as to where and what company would be one of the best to hook up with. We want a good, salable line, a company that will work with us, one that is not out of reason with respect to prices. Equipment must be good.

Have been taking your publication for a number of years and find that *Radio Retailing* is great and helpful.

FLEMINGSBURG, KY.

CARL R. GRIGSBY

Our June issue Directories were made to order for you. Names, addresses, specifications of lines will all be found there.

Lucky Day

I never found a finer book than *Radio Retailing* and sure consider it a lucky day when I got the first paper about one year ago today.

Accept my sincere thanks.

ALBANY, ILL.

LEROY NELSON

Rep Lists

I note on page 53 of the July issue that you request representatives to register with you, in view of the fact that you receive requests from manufacturers.

As vice-president and chairman of the membership committee for "The Representatives," which you no doubt know is an organization consisting of sales agents representing parts manufacturers, I thought it advisable to write and tell you that a list of our members is available to any manufacturer who may wish to avail himself of same.

Our membership numbers approximately

135 men, in all 48 states. Should any manufacturer of radio parts be interested in securing a list for any one particular territory one may be obtained from our secretary, David Sonkin, 220 E. 23rd St.

NEW YORK

D. R. BITTAN
The Representatives

Penurious Pay

Following is a tabulation of the New York City prevailing wage rates for various skilled mechanics.

The picture is not a pleasant one for radio-electricians, nor for radio instrument

RATES OF PAY FOR SKILLED MECHANICS

(In order to include both organized and unorganized mechanics, the rates published by the New York City Civil Service Commission are shown.)

Mechanic	Present Pay	Work Week	Proposed Increase	Discount
Airport Electrician	\$11.20 per day	40 hours	10%	---
Auto Machinist	9.00 per day	40 hours	10%	---
Auto Mechanic	8.75 per day	40 hours	10%	---
Brookliver	12.00 per day	40 hours	10%	---
Bridge Painter	9.50 per day	40 hours	10%	---
Carpenter	11.20 per day	40 hours	10%	---
Clock Repairer	8.00 per day	40 hours	10%	---
Electrician	11.20 per day	40 hours	10%	---
Enginer	10.00 per day	40 hours	10%	---
House Painter	9.50 per day	40 hours	10%	---
Machinist	9.00 per day	40 hours	10%	---
Pattern Maker	9.00 per day	40 hours	10%	---
Plumber	12.00 per day	40 hours	10%	---
Payer	13.20 per day	40 hours	10%	---
Radio Mechanic	Approx. \$20 per day (\$1800 per year)	44 to 46 hours	40%	(See next page)
Harbor	11.00 per day	40 hours	10%	---
Street Light Worker	11.20 per day	40 hours	10%	---
Mechanic	9.00 per day	40 hours	10%	---

manufacturers whose sales depend upon the income of these radio mechanics.

When it is revealed that the rate for skilled radio men has declined to that of unskilled laborers, one questions the wisdom and purpose of those radio associations which apply themselves to improving the technical knowledge of their members without considering their member's economic welfare.

It appears that glorifying of the radio mechanic as a professional man has had an adverse effect upon his income and, if he is to survive, he must eventually yield to the mature experience and methods of the older crafts. This is equally applicable to employee and employing journeyman.

NEW YORK

AN OLD-SCHOOL RADIO-ELECTRICIAN

Brickbats

In the set specifications you used to print not only the number but the types of tubes used always appeared. This is not done in your last listing and I think so long as you go to the trouble to make up specifications full information should be included.

NEW YORK CITY

M. LESLEY

You're got us wrong, brother. Complete tube types were shown in the June, 1937

issue, our last listing. Must have been some other magazine.

I like to cut out service information but always find some Tricks of the Trade on the other side. Please stop this.

PASSAIC

HYMAN ZIMMER

We're guilty. Sometimes we do back up service items with others. But this is avoided so far as humanly possible. Frequently it is not, unless we print an extra form at considerable cost. We'll try to do better.

Bouquet

Your magazine is the most helpful we have ever been able to get. It gives information when it happens, not months later. We wouldn't be without *Radio Retailing*.

SEATTLE

DAVID E. GOSS
International Radio Co.

Blue Book

Your new Blue Book on trade-ins is going to be a big help to every serviceman and dealer.

ELIZABETH

ALFRED H. BAGLEY

By all means continue your Blue Book. I think it will be of great value to all subscribers.

CINCINNATI

EDWARD A. HELLER

It would be best to have the trade-in Blue Book separate from the magazine if possible.

BELMONT, MASS.

L. C. RUNEY RADIO LABS.

Could the trade-in Blue Book be made up in vest-pocket size? It would be valuable to us, as a Blue Book is to used automobile dealers.

WASHINGTON

GEORGE D. HENDERSON

We are getting ready to reprint the BLUE-BOOK all by itself in a 5 by 7-inch size booklet. This will be available shortly. Naturally, we will have to make a small charge.

Sales Ammunition

I am especially glad to get those very heavy "Sales Ammunition" pages designed to be shown to the consumer and so help overcome sales resistance.

We frame these and place them about the store on the walls, where they attract a great deal of attention.

CHICAGO METROPOLITAN RADIO SERVICE

We've had to drop these pages in the last few issues due to the demand for special sections on other subjects. They'll be in again shortly. Incidentally, we'd like more dealers to tell us what customer objections to shoot at when making up these new Sales Ammunition pages.

FROM THE 1938 CROSLEY ALL-STAR RADIO LINE SENSATIONAL NEW



CROSLEY FIVERS WITH BRILLIANT AMERICAN AND FOREIGN RECEPTION

Combining smart cabinet styling and other advanced features—such as American and Foreign Reception and the Crosley 3-dimensional Mirro-Dial—with superlative performance and lowest price, these new Crosley Fivers are easily the outstanding values in radio. Designed to meet every preference in cabinet style, this spectacular group of Crosley Fivers is now available in upright table, compact table, chairside and console models. See, sell and stock these new Fivers and cash in on the unmistakable “swing to Crosley.”



CROSLEY FIVER

A strikingly beautiful cabinet of pleasing proportions plus new Foreign wave band and the 3-dimensional Mirro-Dial make this new Fiver more than ever “the World’s Greatest Radio Value.” The gracefully rounded front and side panels are of figured walnut veneer with black trim on top and bottom of front panel. Dimensions: 12½” high, 10½” wide, 6½” deep. \$22.95
With Crosley Quiktune Dial. \$23.95

CHAIRSIDE FIVER

A new Crosley creation that provides the ultimate in radio tuning convenience. Serves also as a smart and useful piece of furniture . . . blends harmoniously into the decorative scheme of any room. Incorporates regular Fiver chassis with American and Foreign wave bands and new Mirro-Dial. Dimensions: 17½” high, 12¼” wide, 10¼” deep. Available in 3 attractive color combinations: Chinese Red bakelite top, red feet, black knobs, and jet black wrinkle finish cabinet. \$24.95

Brown wrinkle finish cabinet with black bakelite tray, black feet and brown knobs. \$24.95
Beautiful walnut grained finish with black bakelite tray, brown knobs and black feet. \$27.50

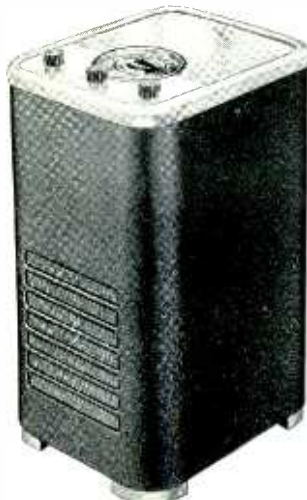

QUIKTUNE DIAL

Swing quickly from one station to another with a simple flick of the dial. Hand hammered bronze escutcheon with ten openings. Call letters provided for insertion in dial openings.

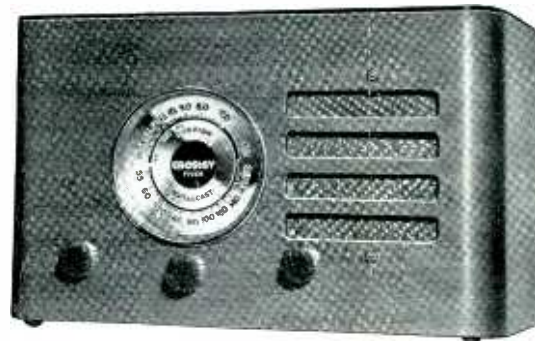

FIVER COMPACT

Another brilliant Fiver in the popular compact type cabinet. Uses the same Fiver chassis and offers all the famous Fiver features . . . receives both foreign and American signals. Rounded front and side panels of figured walnut veneer. Dimensions: 8½” high, 13½” wide, 6½” deep. \$22.95
With Crosley Quiktune Dial. \$23.95



FIVER CONSOLE

A superb 5-tube console model Fiver that offers all the famous features of the regular Fiver plus an 8” Electrodynamic Speaker. Top and front panels are figured stump walnut with fluted pilasters. Dimensions: 38” high, 22½” wide, 10½” deep. \$39.95
Also with Crosley Quiktune Dial. \$39.95

THE CROSLEY RADIO CORPORATION - CINCINNATI POWEL CROSLEY, Jr., President

Home of “the Nation’s Station”—WLW—500,000 watts—70 on your dial

YOU'RE THERE WITH A CROSLEY



TOUCH TUNING

MEANS *More* SALES *More* PROFITS FOR YOU



MODEL F-107—10 TUBES—3 BANDS



Just press a button—that's all

It's a natural sales scoop—packed with sales features that give your customers MORE FOR THEIR MONEY. It's packed full with sensational features that give you more to talk about—more to demonstrate—more to sell—a bigger opportunity for profits.

G-E TOUCH TUNING—with 16 button controls. Fully automatic. Just press a button—that's all.

G-E TONE MONITOR—an amazing improvement... this newly perfected circuit corrects tone distortion.

G-E LOUVER DIAL—"easy to read as a ruler" from natural standing or sitting position. Incorporates VISUAL 4-point TONE and VOLUME CONTROLS.

G-E "Custom-craft" CABINETS—smartly styled.

Beautiful and rare veneers—plus 10 additional sales features.

General Electric Is Backing Its Sensational New Line with the Most Far-reaching and Sweeping Advertising Program in Its History.

in MAGAZINES—a smashing schedule that will help you sell G-E Radios.

in NEWSPAPERS—Right now... 637 newspapers in 473 cities are telling the G-E Radio story to still more millions.

ON THE AIR—every week the G-E "Hour of Charm" tells the G-E Radio story to still more millions.

ON BILLBOARDS—throughout the nation the G-E Radio story is told to America's outdoor population.

with ACTION WINDOW DISPLAYS—in thousands of windows telling the G-E Radio story.

and 10 SALES-MAKING SALES PROMOTION ITEMS—to help you sell G-E Radios.

GET ABOARD THE G-E RADIO BANDWAGON FOR EXTRA SALES AND PROFITS

The New



GENERAL ELECTRIC RADIO

FOR REPLACEMENTS SPECIFY GENERAL ELECTRIC PRE-TESTED TUBES

Appliance and Merchandise Department, General Electric Company, Bridgeport, Connecticut